



nelo
NEW INTERIORS

**QUALITY, FEATURES
AND DESIGN TIPS**



MORE ADVANTAGES FOR YOUR SUCCESS



TESTED DURABILITY

Our furniture combines maximum quality and tested durability. As a testament to our quality, environmental and energy management, nobilia is certified according to the ISO 9001, ISO 14001 and ISO 50001 standards.



PROVEN SUITABILITY FOR EVERYDAY USE

We test furniture, components and materials in our QM lab to guarantee that they will withstand daily use for over 15 years. Independent seals of quality like the TÜV's GS seal for tested safety and the RAL's "Golden M" quality mark ensure that our products meet strict requirements in terms of material durability, safety, quality, environmental and emissions standards.



QUALITY FOR EVERY BUDGET

The comprehensive nobilia catalogue caters for around 80% of the market – from the entry level to the more upscale price range, we fill all of our customers' needs. This variety makes us a market leader and a particularly attractive option for a wide range of customers.



EXCELLENT ASSEMBLY

Thanks to our elaborate design and easy assembly, flaws can be avoided and a high quality of the completed piece of furniture ensured. For professional and precise assembly, technicians can receive intensive training at our assembly academy.



QUALITY AND SERVICE FROM A SINGLE SOURCE

At four locations in Germany, we produce around 8.5 million cabinets per year on an area of 439,000 m². In addition to our consistently high quality, you will also benefit from a complete product range from a single source – from intelligently constructed furniture and worktops to sinks and hand basins through to electrical appliances from leading brands. Thanks to the fastest processing and largest field sales force in the industry, we offer first-class service you can count on.



DEMONSTRATED SUSTAINABILITY

Our wood materials fulfil the strictest formaldehyde emissions standards in the world according to TSCA Title VI (USA), the Prohibited Chemicals Ordinance (Germany) and F-Four Star (Japan). Our raw materials come from PEFC-certified forests. nobilia furniture is in compliance with emissions class A, the best emissions class according to RAL GZ 437. Many of our fronts are also certified according to the "Blue Angel" label for high environmental and health standards.

OUR **ADDED** QUALITY AND EXPERTISE

From the outer design to the inner strengths:
discover the added benefits of nobilia furniture and its components.

QUALITY AT FIRST SIGHT

- 08 Overview of marks of quality
- 10 Carcases and fronts
- 16 Worktops and upright systems
- 24 Genuine wood veneer surfaces
- 26 LINE N
- 30 Niches
- 32 Additional materials and surfaces
- 34 Xtra Hob hot plate extractor fans
- 36 Sliding door systems



FLEXIBLE MODULAR DESIGN

- 38 Overview of marks of quality
- 40 n144 grid system
- 42 System heights and ergonomics
- 44 Carcase – design and assembly
- 46 Base units
- 48 Tall units
- 50 Plinth feet and plinth panels
- 52 Wall units
- 54 Lighting systems
- 58 Product features for the living room and bathroom





PERFECTION TO THE CORE

- 62 Overview of marks of quality
- 64 nBOX drawer system
- 70 Functional fittings
- 72 Sensys hinge technology
- 74 Flap systems



HIGH-QUALITY SERVICE YOU CAN COUNT ON

- 76 Overview of marks of quality
- 78 Quality processes
- 84 Made in Germany
- 86 Packaging and assembly
- 88 Sustainability

QUALITY THAT SETS STANDARDS IN EVERY ROOM

Individually designed kitchens from highly automated production – our expertise as a market leader offers enormous potential for surprising synergies, related products and new markets.

The nobilia range extends far beyond the kitchen. With a comprehensive furnishing portfolio for the kitchen, living room and bathroom, we create holistic and cohesive living concepts that are perfectly tailored to individual spatial needs. Our expertise enables synergy effects that are impressive in every space. Stable workmanship, durable materials and carefully thought-out designs offer solutions that are as flexible as they are sustainable. Everything from a single source.



www.blauer-engel.de/uz38



Excellent quality

Our furniture is certified by independent testing institutes and offer your customers tested durability and functionality.

More than kitchen

Our trademark: a cleverly structured range for every room. Whether kitchens, bathrooms or living rooms, nobilia has the perfect solution for every room and need, with a wide selection of materials, décor and colours as well as personalised design options and high-end furniture technology.



QUALITY AT FIRST SIGHT

Visibly well-designed: nobilia quality can be seen, felt and experienced every day at first sight.



10

CARCASES AND FRONTS

Robust chipboards and medium-density fibreboards ensure high stability. The various designs enable individualised advantages – the double-sided melamine resin coating, for example, is particularly hard-wearing.



16

WORKTOPS AND UPRIGHT PANELS

Our worktops live up to their name – they have been specially designed for a wide range of everyday uses in the kitchen and are thus quite durable. Robust, durable surfaces with real ceramic and quartz material beneath offer exceptional resistance to wear.



LINE N

Handleless design that's both modern and functional. Our handleless LINE N designs are available with all smooth fronts. A cohesive range with matching front uprights and handle profiles make LINE N the ideal solution for purist and minimalist interior concepts, offering a sense of spacious calm and clear lines.

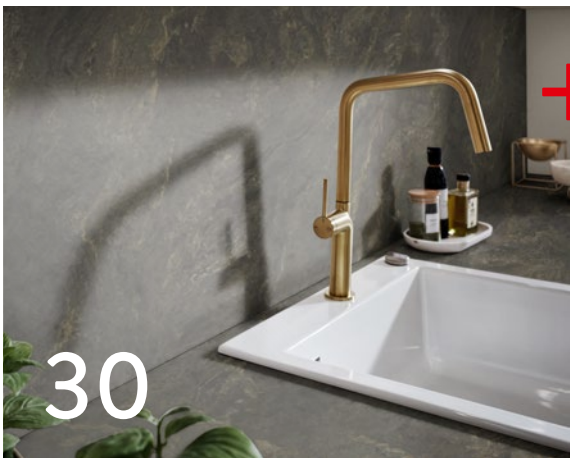

MORE MATERIALS AND SURFACES

Our innovative surfaces and materials for niches, sinks and hand basins stand out with their high quality. They are easy to clean and wear-resistant – true everyday champions that are perfectly suited for daily use.



XTRA HOB HOT PLATE EXTRACTOR FANS

The nobilia Xtra Hob hot plate extractor fan is our proprietary development and offers added benefits. The Xtra Hob combines excellent design with innovative functionality and offers the option of either top-mounted or flush installation.



SLIDING DOOR SYSTEMS

As a room divider or for built-in or walk-in wardrobes: our sliding doors are true multi-talents when it comes to the effective use of surfaces where space is limited. They can be tailor-made and thus are suitable for a range of uses in the kitchen, bathroom or living spaces.

CARCASES AND FRONTS – ALWAYS THE FIRST CHOICE!

Carcases and fronts define the character of each piece of furniture and are important factors in the customer's decision-making process. The look, feel and durability are essential as they have to endure everyday use. That's why it's so important that the material is wear-resistant, robust and low-maintenance.



CARCASE MATERIAL

- 16 mm thick carcass sides, direct melamine resin coating on both sides
- Extremely hard-wearing and low-maintenance
- Robust PP edging on the front edge
- Paper edging for the remaining edges

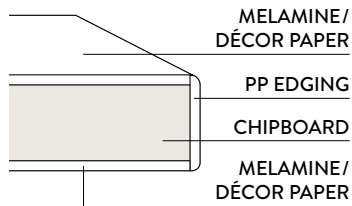

AN EXTRA TOUCH OF QUALITY



- Stable 16 mm carcass with robust melamine resin coating
- Exterior carcass colour options can be freely selected at no extra cost
- Glass wall units, shelves, wall units with open compartments and display cabinets come as standard with interior and exterior carcass décor, creating a harmonious overall look
- Optional versions: interior carcass that matches the exterior carcass available in slate grey



Exterior carcass décor

- Free choice in the latest carcass colours
- All carcass colours are available at no extra charge
- Décor selection possible for set or for individual items
- Exterior décor on all exterior sides, including wall unit bottom shelf and front edges
- Visible joints are also featured in the exterior décor
- Visible carcass sides at no additional cost



Interior carcass décor

- Standard interior colour of carcass: white – for an optimal overview and a feeling of cleanliness, hygiene and clarity
- Glass wall units, shelves, wall units with open compartments and display cabinets are standard interior features of exterior décor. This creates an overall cohesive, harmonious look



Optional interior décor in slate grey

- With this carcass décor, the slate grey interior carcass is available in the same colour as an optional feature
- Allows for seamless and elegant coordination with the entire furniture interior
- Additional cost (MP-KID) for each cabinet

FRONT MATERIALS

Make the right choice: discover the special features and advantages of the various front designs.

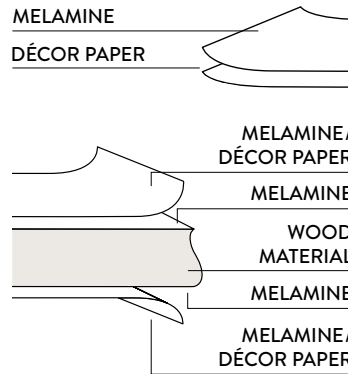

Melamine direct coated

- Optimal for kitchen furniture
- Extremely resilient
- Surface could contain fine textures
- Excellent wood reproduction in terms of look and feel
- Easy-care
- Affordable

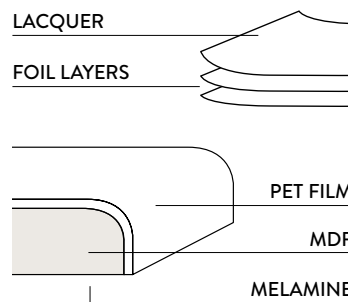

Lacquered laminated fronts

- Lacquered PET film
- High gloss or softmatt version
- Smooth fronts, vertically seamless
- Rounded and seamless on all sides as frame design
- Attractive alternative for genuine lacquer fronts
- Outstanding value for money

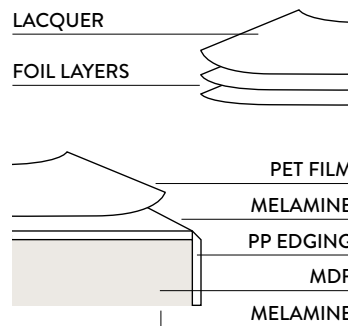

Lacquered laminated fronts with anti-fingerprint coating

- Ultra-matt with PP edging on all sides
- Extremely resilient
- Very easy to clean thanks to innovative anti-fingerprint coating
- Wear-resistant and highly cross-linked functional layer

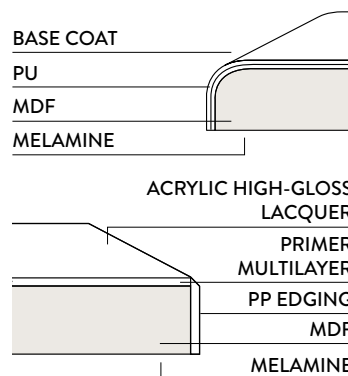

Lacquered fronts

- Pure material appeal
- Hard-wearing, easy to clean
- Seamless front faces in honed lacquer and high gloss lacquer
- Fronts in ultra high gloss with PP edging on all sides
- Honed lacquer with slight texture, for better scratch resistance

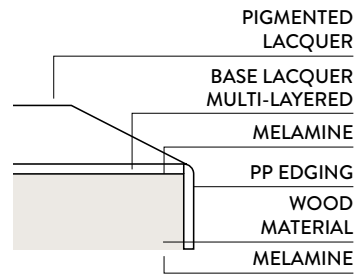

Premium honed lacquered fronts with anti-fingerprint coating

- Premium honed lacquer with PP edging on all sides
- Brilliant colours thanks to special matt finish technology
- Outstanding care properties
- Extremely high abrasion and scratch resistance

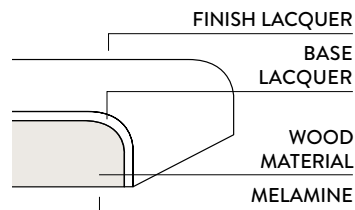

Perfect honed lacquered fronts with anti-fingerprint coating

- Lacquer, perfect honed with lacquered edges on all sides
- Brilliant colours thanks to special honed finish technology
- Outstanding care properties
- Extremely high abrasion and scratch resistance

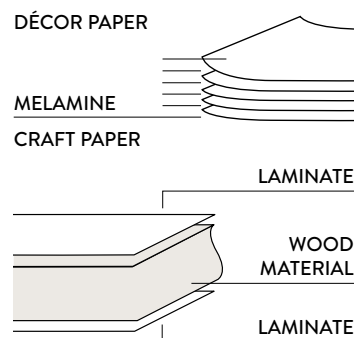

Laminate fronts

- Extremely resilient
- The surface is multi-layered and therefore thicker than the melamine front
- Sturdier than the melamine fronts
- Easy-care

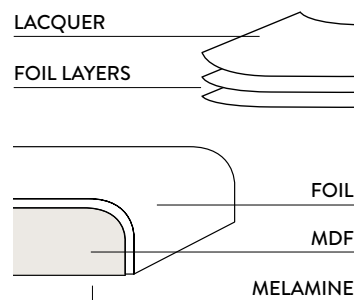

Foil-coated fronts

- Seamless rounding on all sides possible
- Extremely resilient
- Also ideal as a framed front, seamless front face
- An attractive alternative to genuine wood or lacquer
- Outstanding value for money

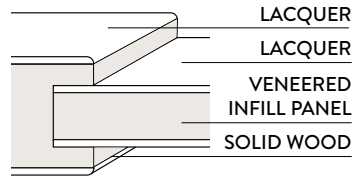

Genuine wood fronts

- Genuine wood framed door with veneer infill panel, lacquered
- Panel made of solid wood, lacquered
- Due to the lacquer coating the surface is hard-wearing and easy to clean
- Upper price structure

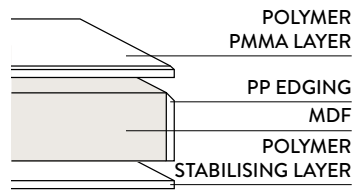

Glass appearance fronts

- High-quality acrylic
- Surface is easy to clean thanks to homogeneous material without pores
- Real glass appearance
- Upper price structure

CARE TIPS

We have compiled the most important care tips on our website so that you can enjoy your nobilia furniture for some time to come.



Show your customers how fast and easy it is to clean our surfaces.





AN EXTRA TOUCH OF QUALITY



- Three high-selling front product lines are equipped with an innovative anti-fingerprint coating
- Our wood materials are sourced from sustainably managed, PEFC-certified forests. The premium honed lacquered fronts are also produced without fresh fibres and are fully recyclable, allowing them to be re-used at the end of their service life
- nobilia's expertise in the development of technologically advanced fronts is incorporated into all of our décors and guarantees quality that extends far beyond the kitchen and is therefore also available in the bathroom and living room
- Our high quality standards apply to all fronts and product lines, regardless of the price segment



WORKTOPS AND UPRIGHT PANELS THAT MEET THE HIGHEST REQUIREMENTS

nobilia worktops combine modern, authentic décors with exceptional everyday practicality. The range of materials and thicknesses offer the right solution for every need. Thanks to the variety of designs, the worktops can be easily combined with all front and carcass décors. Perfectly coordinated upright panels and niches give the overall look a cohesive appearance.

AN EXTRA TOUCH OF QUALITY



- High-quality worktops and upright panels for every budget
- Everything from a single source – even ceramics and quartz: one order, one delivery

Standard

- 38 mm three-layered chipboard with hard-wearing laminates (CPL/HPL), versions: Slim Line (16 mm) and console panel (100 mm)
- High heat, scratch and abrasion resistance, durable

Xtra

- 16/38 mm worktop with 3D surface for an authentic natural stone or solid wood look
- Extra water-resistant, hygienic, not prone to swelling, robust and impact-resistant thanks to innovative functional layer (9.4 mm)
- microPlus® anti-bacterial surface as standard

Xtra Ceramic

- Patented 16 mm worktop with 6 mm thick ceramic coating
- Stain-, scratch-, water- and heat-resistant and low-maintenance
- Impact-resistant design edges for a long-lasting elegant look

Quartz

- 12/38 mm worktop with solid quartz
- Exceptionally robust, scratch-resistant and durable
- Non-porous surfaces: water-resistant without impregnation, low-maintenance and hygienic

Upright panels

- All-round aesthetic: upright panels in four thicknesses, modern décors and a large variety of materials – also available in various front materials in addition to the carcass and worktop décors

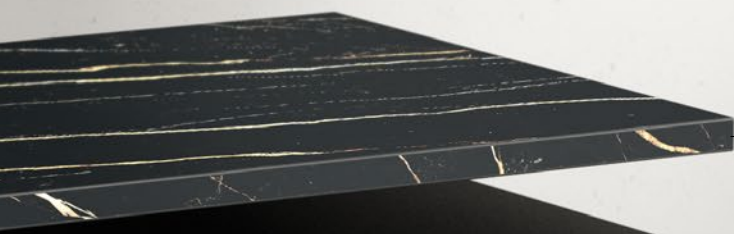

SLIM LINE

16 mm



STANDARD

38 mm



CONSOLE PANEL

100 mm



XTRA

16 mm/38 mm



XTRA CERAMIC

16 mm



QUARTZ

12 mm/38 mm



UPRIGHT PANEL

10 mm/16 mm/25 mm/50 mm

More information on page 23.



STANDARD WORKTOPS: COATED CHIPBOARD

Our 38 mm thick standard worktops made of three-layered chipboard are coated with hard-wearing HPL or CPL material. All standard worktops and the 16 mm narrow Slim Line version come with a 900 cm long sealing tape for cutouts as well as for isolating the worktop over dishwashers. Suitable cutouts can be ordered (AP-AUS). This reduces installation time and the number of complaints.

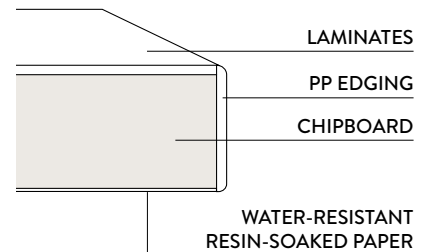

16 mm/38 mm/100 mm



Water-resistant

The underside of the worktop is covered with water-resistant melamine-resin-coated paper and features moisture protection along the back edge.



Durable

The worktops are impact-resistant and exceptionally hard-wearing. Their scratch and abrasion resistance meet the requirements of the DIN 68930 standard. This guarantees that they can easily withstand everyday household use.



Heat resistance

Heat resistance in dry heat up to 180 °C and in moist heat up to 100 °C (DIN 68930). Hot pots should nevertheless always be placed on trivets. Cutting boards should be used when cutting food.

DESIGNS



Standard worktop, 38 mm

- High-quality three-layered chipboards with hard-wearing CPL/HPL laminate surfaces
- High heat resistance
- Scratch- and abrasion-resistant
- Stable shape and look
- Factory-coated décor edges on side cutting edge
- Butt joint bonding with water-resistant D3 adhesive (PVAC)
- Thickness: 38 mm
- Working width: 600 to 1,170 mm (1,200 with N edge, see below)



Slim Line worktop, 16 mm

- Particularly narrow design for a sophisticated look
- Made from high-density fibreboard (HDF)
- High-quality laminate coating in the same décor on both sides
- Highly practical thanks to HPL and CPL surfaces
- All-round 1.2 mm thick décor edge
- Thickness: 16 mm
- Minimum dimensions: 250 × 200 mm
- Maximum length: 3,400 mm



Console panel, 100 mm

- Laminate coating on both sides
- All-round polymer edge
- Available in worktop décor, for dining areas and bar solutions
- At least 50% of the console panel must rest on the support panel; console panels are screwed onto the worktop from below
- It is not possible to install hobs and sinks
- Thickness: 100 mm
- Maximum depth: 1,200 mm
- Maximum width: 1,800 mm



N edge design for standard worktops

- Rounded front edge
- Straight 1.5 mm coated décor edge on the side; optional inlaid N edge available at an additional cost
- N edge sealed at transition to underside for optimal moisture protection



D edge design for standard worktops

- Front and side edges with straight décor edge
- 1.5 mm thick PP edge in worktop décor
- PP edges bonded with water-resistant PUR adhesive
- Interior corners with a radius of 30 mm as standard



Seals for standard and Slim Line worktops

For cutouts in worktops (e.g. for sinks and hobs), sealing must be carried out during installation. A 900 cm long sealing tape with corresponding instructions are provided for this purpose, as well as to isolate the worktop above the dishwasher.

XTRA WORKTOPS – TOP-CLASS QUALITY

Our Xtra worktops are impressive with their pronounced 3D surface texture that creates an authentic natural stone or solid wood look. Matching upright panels and niche cladding are further design options in the same look. Thanks to their multi-layered construction, the Xtra worktops are incredibly robust and are also ideal for the flush installation of sinks or hobs. Under the extra-thick laminate (1.2 mm instead of 0.8 mm) there is an innovative 9.4 mm thick functional layer that significantly increases the worktop's water resistance. Also available as Slim Line.

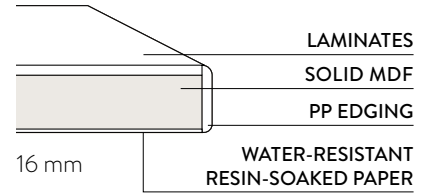
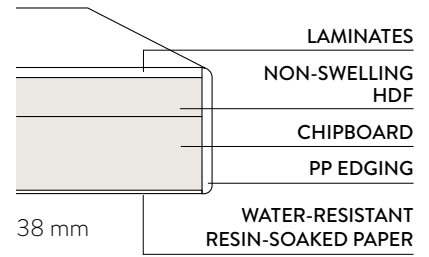

Xtra hygienic

Xtra worktops come equipped with the anti-bacterial microPlus® surface as standard.

Xtra non-swelling

The innovative functional layer ensures that no water can penetrate into the top from above, preventing swelling. The top is thus more water-resistant than a conventional panel.

Xtra robust and impact-resistant

Thanks to its innovative functional layer and the extra-thick laminate, Xtra worktops in thicknesses of 16 and 38 mm are highly robust and meet the high demands of everyday use in the kitchen.

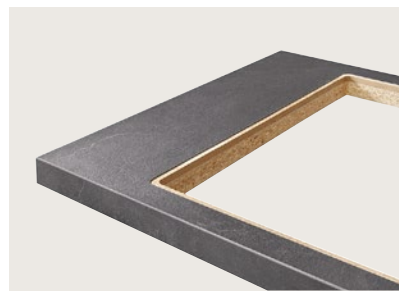

Flush installation

The recess for the flush installation of technically approved hobs and dish-washers is located within the functional layer, ensuring optimal water resistance. The cutouts are pre-fabricated at an additional cost; assembly material and instructions are included.

Easy on-site installation

There are only three additional assembly steps compared to traditional installation: tape, position and grout. The delivery includes a premium natural stone silicone, a joint smoother, tape, and 1 and 2 mm spacers, as well as detailed assembly instructions. Assembly instructions for our worktops are also available in our YouTube playlists.



XTRA CERAMIC WORKTOPS

Xtra Ceramic stands out with its real ceramic surface that combines a natural look and feel. Thanks to a special manufacturing procedure, the fired ceramic is non-porous and thus hygienic, low-maintenance and hard-wearing, making it ideal for the kitchen and bathroom. Natural meets high-tech! Our 16 mm thick, patented worktop is manufactured using an innovative composite construction – 6 mm solid ceramic, combined with a lightweight core layer made from recycled glass. The light construction simplifies logistics and reduces CO₂ emissions during transport. It has received the Green Product Award for its sustainability as well as further awards for design and product innovation. To compliment our 16 mm thick Xtra Ceramic niche cladding is also available.

XTRA CERAMIC

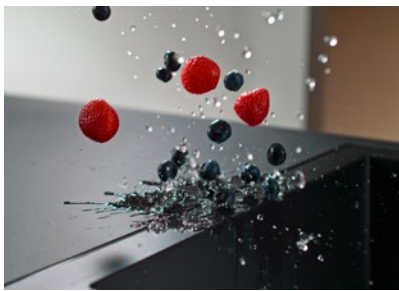
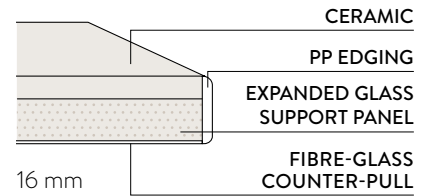

Absolutely water-resistant

No swelling due to moisture – ideal for the kitchen and bathroom. Ceramic is impressive with its durability and maintains its appealing look even after years of use.



Stain-resistant

The Xtra Ceramic worktop is stain-resistant and very low-maintenance. Simply wipe down with a damp cloth – it doesn't get any easier than that.



Exceptionally scratch-resistant

The robust ceramic worktops meet the highest requirements. They are particularly scratch-resistant.



Heat resistance

The Xtra Ceramic worktop is designed for extremes in the kitchen. Xtra Ceramic withstands heat better than other surfaces. Hot pans, pots and objects should nevertheless be placed on trivets.



Impact-resistant edges

Our innovative proprietary development with unique benefits: the impact-resistant design edges act as shockers. Thus, they not only give the worktops a refined look and protect against scratches, but they also prevent the ceramic from chipping along the edges.



Flush installation

As with the Xtra worktop, the flush installation of technically approved hobs and built-in sinks is possible. Cutouts can be ordered at an additional cost, as can modifications for power sockets. Detailed information can be found in the sales manual, section 4.



QUARTZ WORKTOPS

Our quartz worktops combine natural beauty with top functionality. With its elegantly polished surface, this offers not just a sophisticated look, but is also exceptionally robust, scratch-resistant and durable.

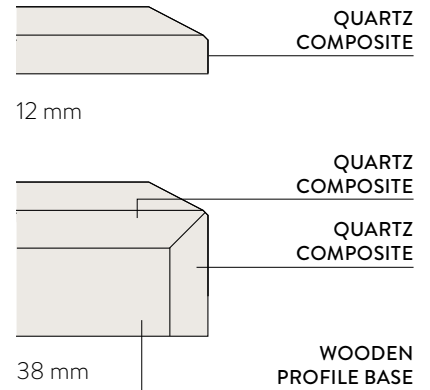

Low-maintenance

The non-porous surface is smooth, hygienic and especially low-maintenance. For minimal cleaning effort.



Water-resistant

Quartz is water-resistant even without impregnation. Perfect for designing your kitchen or bathroom.



Flush installation

As with the Xtra worktop, the flush installation of technically approved hobs and built-in sinks is possible. Cutouts can be ordered at an additional cost.



The quartz panels are available in thicknesses of 12 and 38 mm. The matching niche cladding is 12 mm thick.

UPRIGHT SYSTEMS

Our upright systems stand out with a wide selection of décor, four material thicknesses and ten designs. They enable harmonious end's that perfectly match the front design, worktop décors and all carcass colours whilst also covering the exterior of the carcass. The end uprights can be made flush with the floor using an upright floor seal. Upright floor seals are included as standard without additional cost for base units, sideboards and tall units. Two colours are available, which are to be indicated upon ordering. The upright panels can also be designed to match the carcass height. Our upright systems are ideal for use with wall units and kitchen runs to design the transition between tall units and base units.

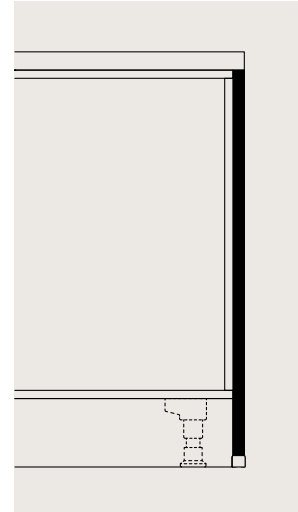

Ten design groups

- Matt (suitable for all carcass colours and a selection of worktop décors and front colours)
- High-gloss (in thicknesses of 16, 25 and 50 mm)
- Premium honed lacquer laminate (only available in thicknesses of 10 and 16 mm)
- Premium honed lacquer (only available in thicknesses of 10 and 16 mm)
- Ultra high-gloss lacquer (only in a thickness of 16 mm)
- Honed lacquer (only in thicknesses of 10 and 16 mm)
- Perfect matt lacquer (only in a thickness of 16 mm)
- High-gloss lacquer (only in thicknesses of 10 and 16 mm)
- Xtra (in thicknesses of 16, 25 and 50 mm)
- Polymer glass (only in thicknesses of 10 and 16 mm)

Characteristics

- In thicknesses of 10, 16, 25 and 50 mm
- The exact upright panel height is calculated by taking the carcass height plus the plinth height (subtracting 8 mm for the upright floor seal)
- The upright panels boast the same tested quality as all of our other materials



Upright floor seal available in 010 black and 014 stainless-steel look.

Available for LINE N: the special end uprights for handleless kitchens are a seamless extension of the clear lines. Plinth panels are installed continuously. Upright panels optional with LED-illuminated front edge. Learn more about LINE N on p. 26.



HIGH-END GENUINE WOOD VENEER

nobilis genuine wood veneer has been tested according to the high standards of the kitchen industry and is thus exceptionally robust and durable. Whether sideboards, display cabinets, tall units and midi units, wall panels, or dining table and coffee table tops: our range of genuine wood veneer elements is impressive through their high-end workmanship and natural, sophisticated look. Each surface is one of a kind, with an authentic wood grain and lively texture that is hardly visually distinguishable from solid wood.

AN EXTRA TOUCH OF QUALITY



- Overall harmonious look with proprietary stand-alone furniture range: sideboards, highboards, display cabinets, wall panels
- Our veneer design in native oak décor offers versatile design options
- Individual table design thanks to high-end, powder-coated steel base frame
- Wear-resistant surface sealed with hard wax for lasting quality
- Genuine wood veneer, tested to exacting kitchen standards
- Tested safety and health protection
- Completely veneered, even on the sides out of view, for high-quality design and sustainability
- Edges veneered with 2 mm real wood
- Inexpensive alternative to solid wood

Genuine wood veneer

Genuine wood veneer boasts a natural charm, robustness and durability. The veneer is laminated onto a chipboard core and edge-banded, giving it a solid wood look without compromising on quality.

- All-round veneer for a high-end, natural, real wood look
- Genuine wood veneer thicknesses: surfaces approx. 1 mm, real wood edges 2 mm
- Particularly wear-resistant thanks to high-end hard wax sealing
- Great feel
- Matt surface

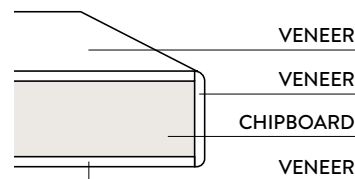

In addition to the most important care instructions, we also offer your customers the right care oil – for the optimal protection of our genuine wood veneer furniture.



RANGE OF ELEMENTS IN GENUINE WOOD VENEER

From genuine wood veneer dining tables and coffee tables to our stand-alone furniture range: nobilia genuine wood veneer furniture in brushed native oak décor maintains its original beauty and practical functionality over many years.



Dining table tops

- Highly wear-resistant table tops thanks to natural hard wax sealing
- Ideal for daily use
- 24 mm thick dining table top with Swiss edge for particularly refined look
- Table dimensions: table height 760 mm, table width 950 mm
- Available table lengths: 1,600, 1,800 and 2,000 mm

Table frames for dining tables

- Three frame designs in black from high-end powder-coated steel
- TÜV-certified: GS seal for safety and quality standards
- Tool-free extension, with front-slide or synchro-front-slide mechanism and two extension leaves (500 mm each)

Coffee tables

- Coffee tables with genuine wood veneer table tops in 16 mm thickness
- Natural hard wax sealing
- Available in sizes of 800 x 800 mm and 1200 x 800 mm
- Table frame in black, powdered steel, including furniture pads



Stand-alone sideboards, tall and midi units

- The vertical grains lend the doors and carcass a natural look
- Available in wall-hung and floor-standing designs
- All models are equipped with mechanical opening support mechanisms
- Available in heights of 864, 884, 1,296, 1,316 and 2,036 mm

Stand-alone display cabinets

- With segmented glass door and one glass shelf in grey glass
- Available in wall-hung and floor-standing designs
- All models are equipped with mechanical opening support mechanisms
- Available with optional matching LSIDHVEF interior LED lighting
- Available in heights of 1,296, 1,316 and 2,036 mm

Stand-alone wall panels

- Genuine wood veneer with horizontal texture
- All-round 2 mm veneered edge
- With black spacer frame, 19 mm thick
- The board can be positioned on either the right or left
- Available with optional MP-WPL LED lighting design
- Available in a width of 1,200 mm and a height of 720 mm

LINE N FOR HANDLELESS DESIGNS

For a minimalist and consistent aesthetic: LINE N enables handleless fronts for base units, tall units and wall units thanks to integrated, ergonomic recessed handles that allow you to easily open drawers, pull-outs and doors. Vertical and horizontal recessed handles are available for base units and tall units, highlighting their clear lines. LINE N is available with all flat fronts in our catalogue as well as with a range of matching upright designs for an all-round harmonious look.



HANDLE PROFILES



Handle profile colours

- Handle profiles made of anodised aluminium for high corrosion resistance and lasting elegant look
- Available in ten colours
- Only one handle colour can be chosen per order
- An overview of our handle profile colours can be found in our sales manual, section 8

Interior and exterior corners

- End caps as well as interior and exterior corners are made of colour-matched plastic
- The handle profiles feature installation-ready straight cuts and mitre cuts for interior and exterior corners

HANDLE PROFILE OPTIONS

The C-channel and L-section profiles offer convenient and secure handling with a uniform grip height of 30 mm.



L-section profile

- On base units, L-section profiles are generally mounted beneath the worktop
- They are mounted beneath the top shelf of highboards
- Optional LED lighting available for L-section profiles of base units and highboards at an additional cost (L-section profile MP-NGML)



C-channel profile

- On base units and tall units, the recessed handle with a C-channel profile is positioned between the fronts
- Optional at additional cost (MP-NGMC): LED lighting for the middle and bottom recessed handle, illuminating both profile grooves

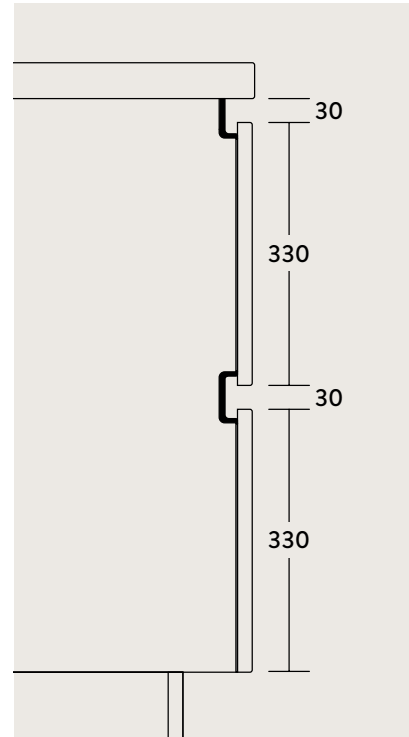

CUTTING

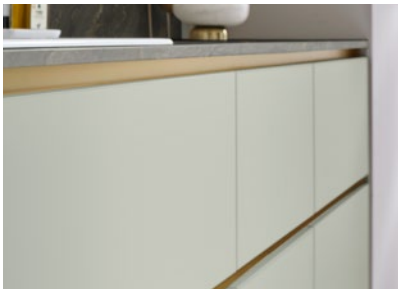

Transitions

- Adjacent base units are cut all the way through for a continuous profile
- For run endings with front or end uprights, the last carcass side is cut through, and the recessed handle ends at the upright panel
- L-section profiles beneath induction hobs can be cut in lengths of 550, 750 and 850 mm (5 mm depth). The necessary depth depends on the hob ordered. The appliance must be indicated upon ordering



Through cuts

- Through cuts are made for wall connections, front fittings, end uprights, end front uprights and the transition from C channels to L sections in continuous profiles



Pockets and profile end caps

- Pockets are cut into the base units and tall units with visible carcass sides
- Carcass sides are pre-cut at a depth of 8 mm
- Profile end caps are included for pockets and through cuts and are to be installed upon assembly

RECESSED HANDLE OPTIONS



Horizontal recessed handles

- Horizontal recessed handles create a continuous line and are ideal for combining tall units and base units
- Horizontal handle profile, mounting materials, 90° corners and end caps are included in the final price
- Maximum profile length: 4,000 mm



Vertical recessed handles

- Enable large doors to be easily opened
- Intermediate and end recessed handles (with a design width of 25 mm) are planned and charged individually
- An end upright is always necessary for design ends and adjacent base units



Floor-to-ceiling designs with continuous recessed handle

- Floor-to-ceiling designs with continuous, vertical recessed handles are possible up to 3,000 mm
- Corresponding dresser units are set upon tall units and connected by a continuous recessed handle (NGMA300/NGMZ300)



Curve end unit

- Natural contours on the end fronts for free-flowing lines
- Width: 450, 600 or 900 mm; height: 360, 432, 720 or 792 mm
- LED lighting (L-section profile MP-NGML/C-channel profile MP-NGMC) available at an additional cost
- Connection location must be indicated upon placing order (connection side = closed front end)



Integrated lighting

- Integrated lighting for recessed handles creates a beautiful ambience for handleless LINE N designs
- Upper and middle horizontal handle available for base units, tall units and highboards with LED lighting available at an additional cost (L-section profile MP-NGML/C-channel profile MP-NGMC)
- Individual runs can also be planned with LED lighting

END OPTIONS

To account for the worktop depth for ceramic hobs and sinks, base units and tall units must be offset by 15 mm. A veneer is required for the gap to the wall. There are three options available. The overhang of the LINE N kitchen worktops is 3 mm in front and 1.5 mm on the sides. For quartz and ceramic it is 2 mm on the sides.



End uprights

- End uprights are available in all décor groups with a depth of 598 mm (see sales manual, section 5)
- End uprights are available to ensure flushness in the front (NUWA/NUWK)

End front uprights

- End front uprights (NUWF/NHWF) with an L-section profile allow the recessed handle to be visually reintegrated into the carcass to terminate the run
- The end front panels with a split appearance (NUWFT) are a continuation of the pull-out design, giving the worktop a floating look

Cover profiles

- The stainless-steel-coloured cover profile (NADP) for a depth compensation of 15 mm is a cost-effective solution

HANDLE PROFILES FOR WALL UNITS



Wall units

- LINE N wall units come with a stainless-steel-coloured, anodised and brushed profile strip at the base as standard
- This profile strip is available for further standard wall units at an additional cost (MP-WOG)
- Not suitable as sideboard
- Available in wall unit heights of 360, 576, 720, 792 and 864 mm

Optional at additional cost

- Profile strip with LED lighting (MP-LLIN) or light shelf as bottom shelf (MP-LAN)
- Integrated lighting designs NOVA PLUS and MANILA PLUS in both the wall unit and base unit
- As a special design, the depth of the base units can be shortened to the depth of the wall unit



AN EXTRA TOUCH OF QUALITY



- Handle profiles in many colours, made of anodised aluminium
- Continuous handle profiles up to 3,000 mm in height
- Lighting available for horizontal handle profiles
- Cover profile available as cost-effective end solution
- End uprights in all décor groups or end front uprights with handle profile
- Carcase sides pre-cut for recessed handle installation
- Installation-ready handle profiles with straight cuts and mitre cuts
- LINE N available for all smooth fronts (PG 1 to 10). LINE N fronts are designated by the LINE N logo in the sales manual, section 1
- LINE N wall units with profile strip on bottom shelf available in various heights



INNOVATIVE NICHE SOLUTIONS

From glass niches and patterned niches to 3D effects, our niche solutions offer optimal protection for walls behind sinks and stoves, adding a unique touch with minimal effort. Heights and widths can be flexibly adapted. Individual modifications for drill holes and power sockets are also possible. It is recommended to plan in combination with the NPUK, NKPU or WAPN profiles (see accessory list, section 2) for all niche cladding.

NICHE CLADDING



Carcase, worktop and high-gloss décors

All-round harmonious: our niche cladding is available in all carcass and worktop décors and complement our high-gloss fronts. They are coated on both sides, 16 mm thick and feature a horizontal structural direction. The edges are coated all the way around. Price calculated per 100 mm or part thereof.



Digital print, 3D digital print and 3D texture

Excellent quality that you can see and feel: nobilia offers a variety of modern digital print patterns with and without 3D effects and tactile textures. Designs including tile and wood looks appear deceptively real and often feel just as authentic while also being easy to replace, making them particularly ideal for renovation projects.



Glass and mirrors

Mirror niche cladding made of real mirror material is lacquered on the back. The niche glass cladding is 16 mm thick and consists of a 12 mm thick support panel with a 4 mm glass coating and all-round PP edging in silver.



Stainless-steel, yellow-gold and bronze-metallic looks

Stylish back panels: Our niche cladding in metal décors is 16 mm thick, coated on both sides, with an edge coating that goes all the way around. The HPL material with integrated real metal film lends the cladding its look. Designs: bronze-metallic, yellow-gold and stainless-steel look. Maximum height of 1,200 mm, maximum width of 2,580 mm.



Xtra

Like the Xtra worktop, the 16 mm thick Xtra niche cladding stands out with its unique 3D surface based on natural stone or solid wood. This is achieved through a particularly thick (0.8 mm) laminate. Xtra niche cladding is non-swelling and impact-resistant.



Xtra Ceramic

16 mm thick Xtra Ceramic niche cladding is made of the same material as the Xtra Ceramic worktop. With a 6 mm ceramic coating, an ultra matt surface and a three-sided, 1.2 mm design edge, it combines a sophisticated look with innovative functionality. It is hard-wearing and water- and scratch resistant. Maximum height: 559 mm; maximum width: 3,100 mm.



Quartz

12 mm thick quartz niche cladding with a polished surface and three-sided, polished, double-bevelled edges is made of the same material as the quartz worktop and offers the same practical advantages: low-maintenance and naturally water-resistant without impregnation. Ideal for moisture protection, for example behind the sink.

Maximum height: 563 mm; maximum width: 3,000 mm.



Country house style

16 mm thick veneered niche cladding. Its panel-like, vertical grooved structure (100 mm wide) in a country house style lends designs a unique charm. Available in 901 lacquered satin grey. Width: 250 – 1,200 mm.



AN EXTRA TOUCH OF QUALITY



- Niche cladding is available in a variety of designs
- It offers optimal protection for the wall behind the sink or stove and is low-maintenance and easy to clean
- Precise dimensions, cutouts, bevels and modifications for power sockets are available on request and are pre-fabricated for ceramic, quartz, glass and mirrors
- For complex designs: niche cladding (glass, mirrors, Xtra Ceramic, Quartz) to be ordered upon installation of kitchen (lump-sum billing only possible with Erst-AB)
- Excellent value for money: a variety of designs for every need



STRONG MATERIALS FOR SINKS AND HAND BASINS

Everything from a single source: in addition to kitchen and bathroom furniture, we also offer sinks and hand basins. We focus on the most attractive materials, colours and price segments. Thanks to our durable surfaces and solid workmanship, they are particularly wear-resistant, low-maintenance and hygienic – perfect for everyday use.

OUR SINK MATERIALS

nobilia offers a wide selection of innovative sink materials that perfectly meet both the diverse needs of customers and market demands.

Stainless steel

- Exceptionally heat-resistant and rust-proof (stainless steel is a nickel-chrome alloy)
- Sustainable, 100% recyclable
- Robust, hygienic and safe
- Non-porous surface: easy to clean, no bacterial adhesion, no discolouration

CRISTALITE®

- Water-resistant, non-swelling, highly durable with exceptional hardness
- Hygienic, food-safe, easy to clean
- Light- and colourfast

Fragranit +

- Scratch- and impact-resistant, resistant to all conventional household agents
- Heat-resistant up to 280°C
- Easy to clean, low-maintenance, food-safe

Ceramic

- Robust material consisting of clay, loam and water
- Resistant to cold and warm temperatures
- Resistant to acidic substances and impervious to discoloration from food pigments
- Robust surface remains unblemished even under heavy use
- Hygienic and low-maintenance

CRISTADUR®

- Easy to clean, 100% anti-bacterial
- Highly wear-resistant
- Certified food safety and hygiene (LGA)
- Resistant to brief periods of extreme temperatures up to 280 °C

GRANITEK®

- Combination of natural granite and acrylic resin
- Resistant to impact, brief periods of high temperatures and temperature shocks
- Hygienic, certified food safety and easy to clean
- Authentic natural stone look

KERATEK®

- High-end composite material consisting of quartz, ceramic nanoparticles and a mixture of six acrylic resins
- Exceptionally resistant to impact, brief periods of high temperatures and temperature shocks
- Hygienic, certified food safety and easy to clean
- Ultra compact soft-touch surface for improved water flow

CRISTADUR® GREEN LINE

- Production in Germany with up to 75% regional quartz sand
- Mostly made of renewable, natural or recycled raw materials
- All of the advantages of the classic CRISTADUR® SCHOCK sink including a 15-year warranty extension

Tectonite

- Temperature-resistant up to 300°C, resistant to cold and heat shocks
- Hard like stone, offering exceptional resistance to breakage, impact, and scratches.
- Resistant to common household acids and alkalis
- Easy to clean, environmentally friendly and 100% recyclable

OUR HAND BASIN MATERIALS

nobilia hand basins are lasting, aesthetic solutions with innovative surfaces and exceptional wear resistance. Functional, low-maintenance and with the necessary durability for everyday use.



Duratek®

nobilia implements tested material technology from the kitchen in bathrooms as well. Duratek® is a high-quality solid acrylic composite material that combines quartz, ceramic nanoparticles and innovative acrylic resins. Its compact, wear-resistant structure and unique aesthetic make it an attractive option.

- Ultra compact and exceptionally wear-resistant
- Velvety feel with elegant matt finish
- Low-maintenance and easy to clean
- Colour stability with lasting brilliant matt colours
- Robust with high scratch and impact resistance

Mineral composite

Unique in the sanitary industry: this environmentally friendly material is approx. 75% dolomite rock, synthetic resin and gelcoat and boasts excellent properties for perfect surface quality. The gelcoat, a material also used in yachts and wind turbines, makes it extremely resistant against UV light, water, wind salt and dirt.

- Very hygienic and low-maintenance thanks to non-porous, seamless surface
- Exceptionally robust and hard-wearing for a long service life
- Environmentally friendly and 100% recyclable

Ceramic

Ceramic sanitary products boast durability, resistance to wear and a hygienic, smooth surface glaze.

- Hygienic, smooth and low-maintenance surface
- Heat-resistant, scratch-resistant, and hard wearing
- Compatible with common cleaning agents
- Colour- and lightfast, even when exposed to intense sunlight



Ideal for use at water stations:

Xtra Ceramic and quartz worktops

Water-resistant without impregnation, hygienic and scratch-resistant: our patented Xtra Ceramic worktop and our quartz worktop are excellent additions to our hand basins. The low-maintenance surfaces are impressive with not just their sophisticated, natural look, but also their high level of durability and practicality.

EXCLUSIVE XTRA HOB HOT PLATE EXTRACTOR FAN

A statement for modern innovation: the Xtra Hob hot plate extractor fan combines unique design and a high level of functionality. With its exceptional look and feel, the Xtra Hob can be harmoniously integrated into a modern, open living concept, distinguished by its understated aesthetic. The high-performance hot plate extractor fan offers the option of either top-mounted or flush installation and represents the state of the art in cooking with its 2-in-1 concept. Intuitive, high-performance and with maximum energy efficiency – the technology of tomorrow today, only with nobilia.

AN EXTRA TOUCH OF QUALITY



- Quick and easy installation
- Flexible placement and planning options with three designs and two possible widths: 600 and 800 mm (bronze version only available in 800 mm)
- Maximum energy, ventilation and grease filter efficiency (Class A)
- Smart, intuitive use
- Dishwasher-safe cover grating and grease filter
- German quality components by manufacturers like SCHOTT, E.G.O. and ebm-pabst
- Can be flush-mounted or top-mounted
- Proprietary development in the electrical appliance segment with unique selling points
- Perfect integration into the Xtra worktop 373 (grey slate), also possible as combination with other worktop décors



CHARACTERISTICS

Proprietary development in the electrical appliance segment with unique selling points: with the Xtra Hob, nobilia is setting new standards in design and user-friendliness with expert development partners. This innovative hot plate extractor fan series is also an attractive option in terms of cleaning and installation.



It doesn't get any easier than this!

Flexible installation: factory-prepared ducted circulation/extraction or unguided circulation – thanks to the patented air inlet that fits perfectly in the frame unit. Innovative details: smart 2-in-1 touch operation and convenient automatic mode (Hob²Hood) – a complete system designed with the modern kitchen in mind.



Xtra Hob in matt black with EuroKera glass ceramic – innovative features

With the unique Onyka glass ceramic, the matt black Xtra Hob hot plate extractor fan sets standards in terms of functionality. The specially treated, scratch-resistant cooking surface ensures lasting quality and an enduring aesthetic without any traces of pots and pans. The low-maintenance surface can be cleaned quickly and easily. Fingerprints and stains don't stand a chance. Available in widths of 600 and 800 mm with ducted circulation/extraction.



Xtra Hob in grey slate – perfect match

The Xtra Hob hot plate extractor fan can be seamlessly integrated into the worktop in harmony with the worktop décor 373 (grey slate reproduction). Available in widths of 600 and 800 mm with ducted circulation/extraction.



Xtra Hob in bronze design – sophisticated accents

The bronze-coloured print makes a striking impression on black glass ceramic. This design blends harmoniously into the bronze elements of our collection – from nBOX design covers and profiles to handles and bar handles, as well as worktop accents, niches, sinks and mixer taps. Available in a width of 800 mm with ducted circulation/extraction.



reddot winner 2024



Excellent hot plate

Top quality, innovative design and first-rate functionality: our Xtra Hob in grey slate décor has received two awards in 2024: the renowned German Design Award's "Gold" award and the Red Dot Design Award.

SLIDING DOOR SYSTEMS – MORE SPACE, MORE CONVENIENCE

Our sliding door systems guarantee smooth, quiet and easy operation thanks to their high-quality materials and precise workmanship. They are durable, reliable and highly versatile. As a room divider or for built-in or walk-in wardrobes: our sliding doors are available in a variety of sizes and designs and can be used for a range of applications. They enable the efficient use of space particularly in smaller rooms and provide solutions for previously unused niches and much more. In larger rooms they create a spacious, open atmosphere and allow for flexible room design.

AN EXTRA TOUCH OF QUALITY



- Easy planning for fewer order and design mistakes: every order is based on a set and includes the set number, rail colour, front décor, and width and height of the entire system
- Nine set suggestions to cover all common design solutions as a completely or partially closed system or as a design with an open niche
- All sets generally consist of a rail set and sliding doors, including ceiling rail mounts, a brush seal and a base rail stop
- A variety of accessories are available, for example sliding door brakes, anti-tip safety brackets, wall connectors, and cover caps for the base and ceiling rails

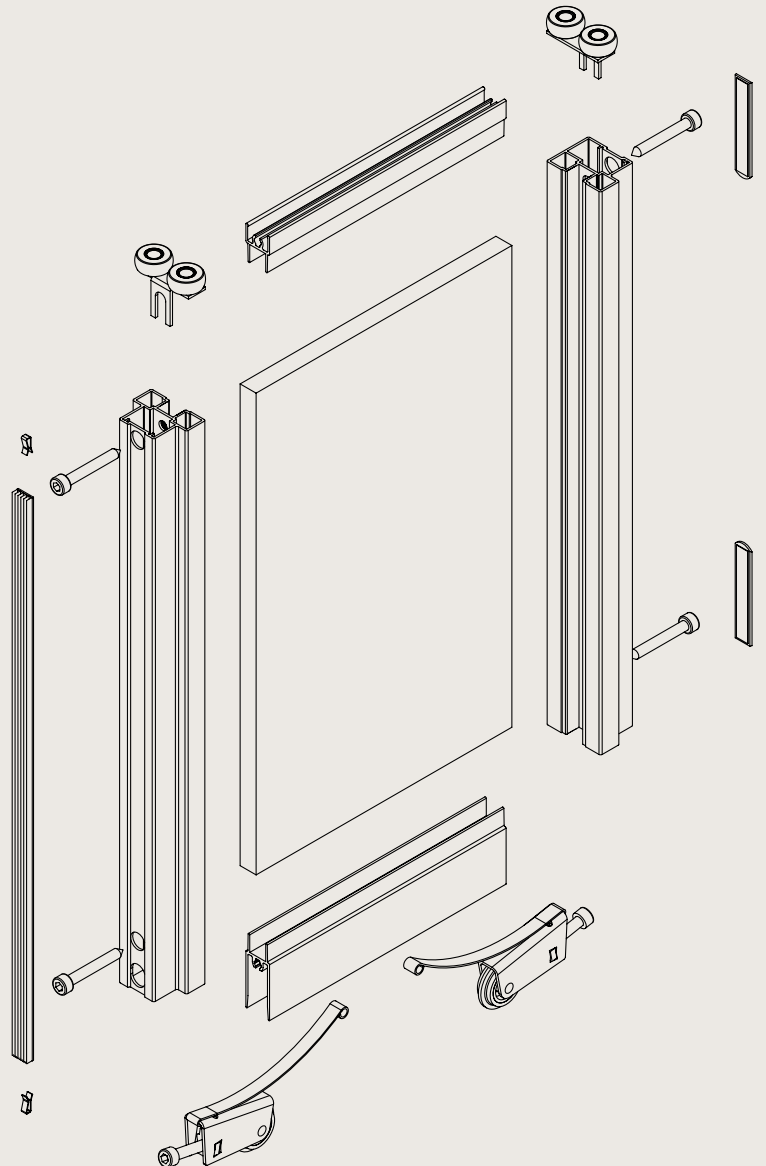

THE SYSTEM

Our rails are made of high-quality aluminium and are a robust, durable solution.
Two rail colours: 014 stainless-steel look and 010 black. Maximum length: 5,000 mm.



Door designs

- 13 original front designs, 1 mirror front
- Door widths: 500 – 1,200 mm
- Door heights: 700 – 2,600 mm, for continuous doors up to 2,000 mm, depending on the décor
- Doors available in split design, with a mullion dividing the panels, at an additional cost.
A separate décor can be ordered for the middle panel at an additional cost
- Minimum door dimensions: 500 x 700 mm

Equipment

- Aluminium frame in 014 stainless-steel look or 010 black
- Panel coated on both sides
- Ceiling rail mounts, brush seal and base rail stop in black or grey included
- Rail set consisting of ceiling and base rails
- Height of ceiling rail: 40 mm (screwed)
- Height of base rail: 6 mm (adhered)
- Installation depths of rail profile: 40 mm, double-rail: 79 mm, triple-rail: 117 mm
- Only suitable for solid bases
- Not suitable for velour- or long-pile carpeting



Raised sliding doors

The AUSHS 1487 safety catch is required for designs with raised sliding doors and will automatically be confirmed and delivered, with charges applied. A connection to the wall and/or to adjacent units is necessary on the left and right.

Optically divided fronts

Doors available in split design, with a mullion dividing the panels, at an additional cost. A separate décor can also be ordered for the middle panel.

FLEXIBLE MODULAR DESIGN

nobilia furniture features a design that combines functionality, flexibility and durability – perfect for tailored solutions that provide lasting enjoyment.



n144 GRID SYSTEM AND FLEXIBLE HEIGHT SYSTEMS

The 144 grid from nobilia enables continuous and ergonomic kitchen, bathroom and living room design with harmonious lines. The combination of four carcass heights, four plinth and three worktop heights allows individually adjustable working heights between 662 mm and 1,102 mm.



CARCASES, BASE UNITS, TALL UNITS AND WALL UNITS

nobilia carcasse elements feature a melamine resin coating on both sides and are robust and low-maintenance. The clever design and high-quality materials ensure high stability and durability: 16 mm thick side panels, 19 mm thick top and bottom shelves for high-boards, tall units and base units. As key design modules, our units are impressive with their attention to quality and detail. All units are pre-assembled for easy installation of the entire design.



LIGHTING

From functional work lights to ambient mood lighting – nobilia offers a variety of lighting solutions. With smart Philips Hue lighting and emotion technology, lighting can be controlled from room to room. Special IP44-certified lighting solutions are available for bathroom applications.



EXCEPTIONAL PRODUCT CHARACTERISTICS FOR THE LIVING ROOM AND BATHROOM

Impressive components of proven nobilia quality, tested in our own QM lab and certified according to the highest standards. Robust tables and chairs, water-resistant bases for hand basin units, offset back panels for optimal air circulation and heavy-duty fittings to support up to 100 kg for wall-hung furniture – nobilia offers tailored solutions for every room that maintain their quality and functionality for years to come.

n144 GRID SYSTEM FOR LIMITLESS INDIVIDUALITY

nobilia's uniform n144 grid system allows the flexible and modular design of our furniture, enabling individual and continuous kitchen, bathroom and living room design without compromises. The result: perfect lines, optimal use of storage space, ergonomic heights, and maximum design variety and safety.



The infinitely adjustable grid can be set between the smallest tall unit height of 1,512 mm to the largest of 2,232 mm, irrespective of whether the standard base unit height of 720 mm or the XL height of 792 mm (shown here) has been chosen.

Our XL height is fully customisable. for not just ergonomic, but also space-efficient kitchen designs. At a comparable working height, the XL offers approximately 10% more storage space.



AN EXTRA TOUCH OF QUALITY



- Uniform, harmonious lines
- Easy planning that can accommodate subsequent changes
- High level of individuality from the standard range, even without custom designs
- Flexible kitchen design
- Versatile use of cabinet elements for base and wall units thanks to symmetrical heights
- Precise integration of electrical appliances

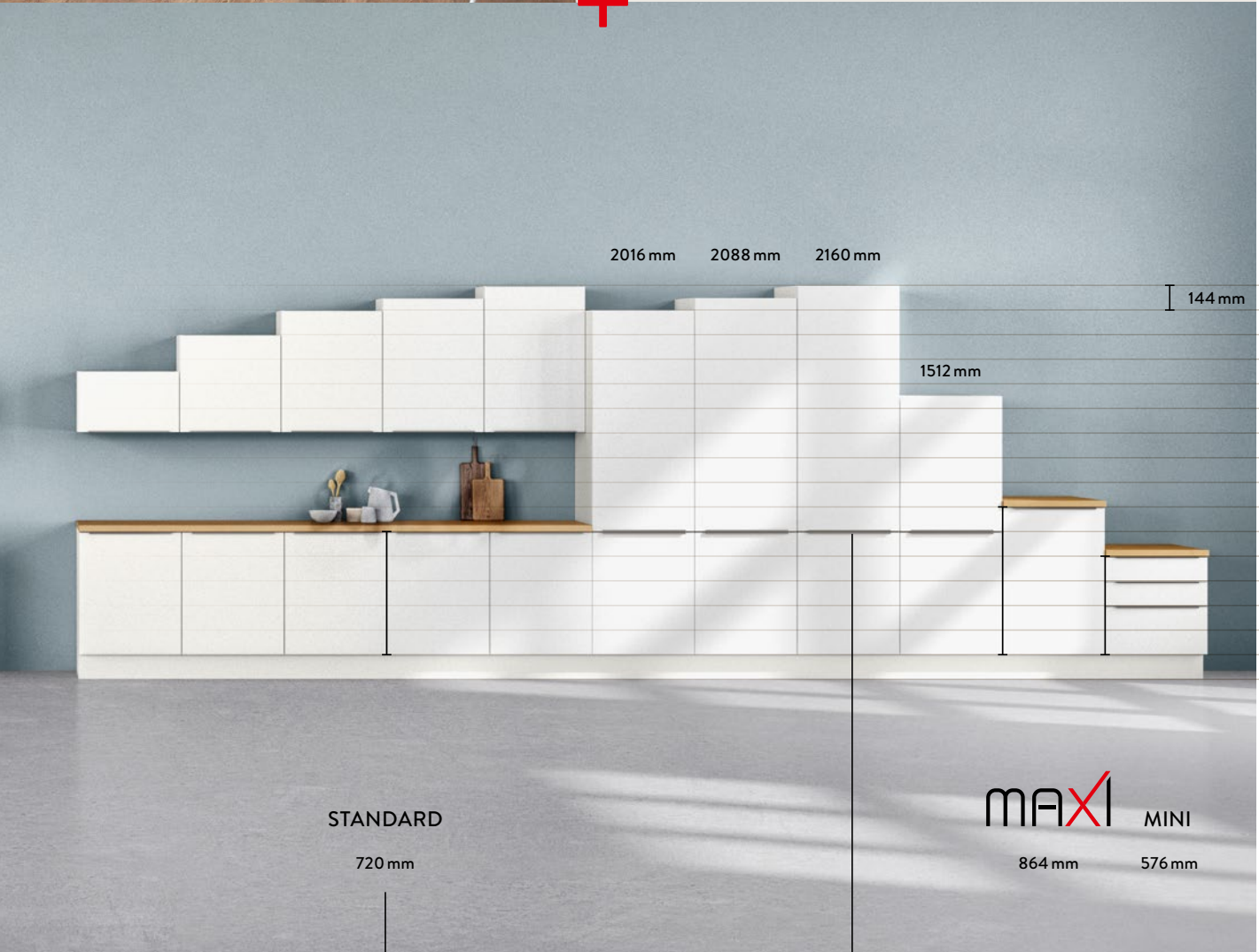

With our base unit heights, we offer a range of customisation options for the kitchen in terms of ergonomics and storage. This is made possible by the three height options – standard, XL and maxi – with a comparable range of elements available.

Our designs emphasise continuous lines down to the last detail. This is achieved by the symmetry of the tall units, wall units and dresser units, which are precisely tailored to the carcass height of the base units.

PERFECT ERGONOMICS WITH FLEXIBLE HEIGHT SYSTEMS

Our flexible height system enables working heights of 662 mm to 1,102 mm, offering a range of customisation options to optimally suit every need.

Four different carcass heights are available. Ergonomic active heights enable a relaxed kitchen experience for a range of carcass sizes and storage needs.

Four plinth heights and three worktop heights available for precise adjustments.





AN EXTRA TOUCH OF QUALITY



Our base unit standard, XL and maxi heights enable individual design options in terms of ergonomics and storage needs. For ease of planning, the abbreviated designations differ only in the last position:

- Base units U*/U*-X/U*-M
- Stove housing HU*/HU*-X/HU*-M
- Cooktop units K*/K*-X/K*-M



120 %	MAXI - 864 mm
110 %	XL - 792 mm
100 % storage space	STANDARD - 720 mm
	MINI - 576 mm

CAREFULLY CONSIDERED CARCASSES

nobilia offers you and your customers nearly limitless design options – with a variety of cabinet elements manufactured in automated series production. The basis for planning and production is an intelligent modular system with different heights for base units, wall units, top units, tall units and special heights for multifunctional planning. Each carcass meets nobilia's high standards in terms of quality: stability and durability thanks to high-quality workmanship and robust materials.

Side panels

- 16 mm thick side panels
- Chipboard with melamine resin coating on both sides – hard-wearing and low-maintenance
- Visible edges in carcass décor
- Stable connections provide reliable support for shelf brackets

Shelves

- 16 mm thick shelves laminated with heavy-duty 1.2 mm PP edging: very robust and impact-resistant, with an aesthetically pleasing soft, rounded look
- 5 mm thick glass shelves for wall units with glass doors
- 6 mm thick glass shelves for wall units with fold-and-lift doors and hinge-up flaps as well as dresser units with plastic or glass roll-up fronts
- 8 mm thick glass shelves for bathroom display cabinets

Shelf brackets

- All-metal shelf brackets
- Safety pin to prevent the wooden shelf from sliding for maximum stability
- High load capacity for wooden and glass shelves: 50 kg/m²

Hardwood dowels

- Shelves, construction shelves and sides with 8 x 30 mm bonded hardwood dowels

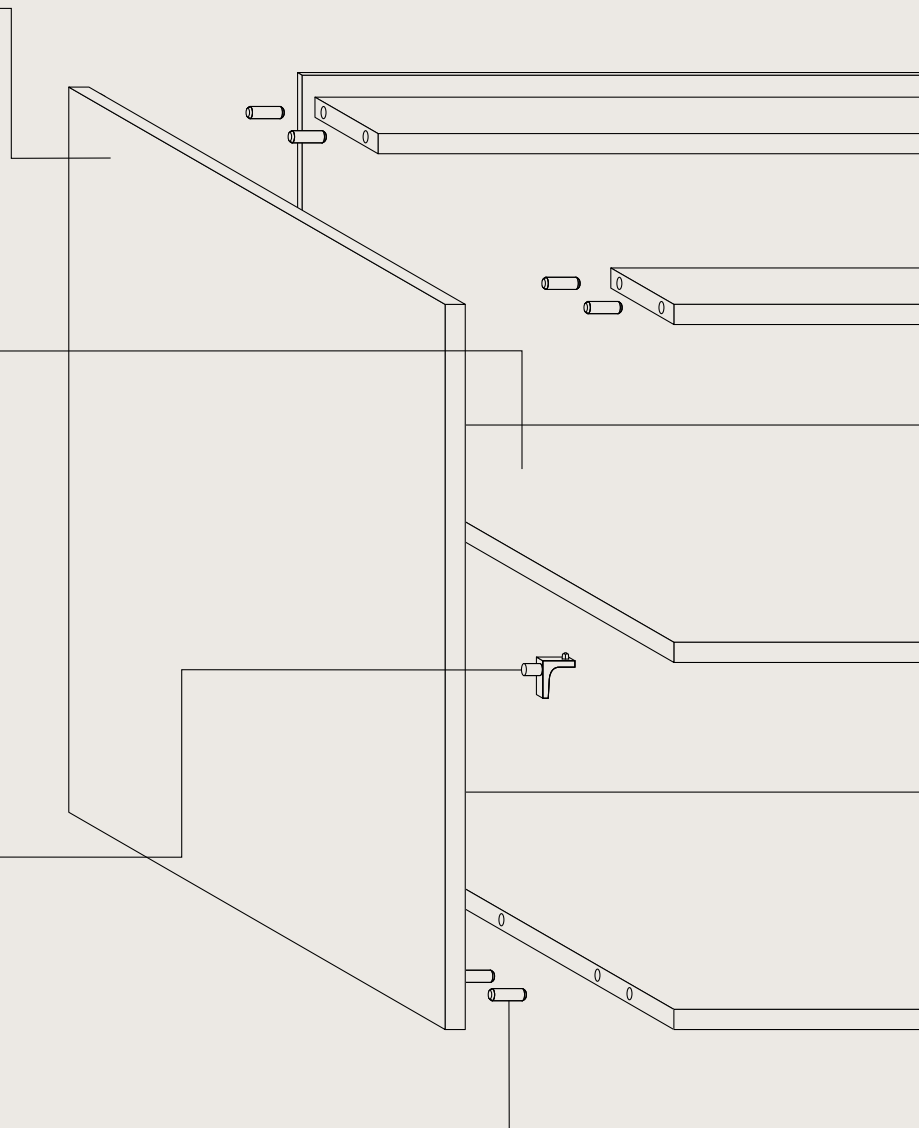

AN EXTRA TOUCH OF QUALITY



- High load capacity and durability: the first-rate design of our carcass elements and well-engineered fitting technology are the result of years of experience and continuous process improvement in production
- PP edge protection: exceptionally wear- and impact-resistant, considerably more robust than conventional carcass edges
- Moisture protection: all-round sealed edges for base and sides ensure neat ends and prevent dirt and moisture from penetrating

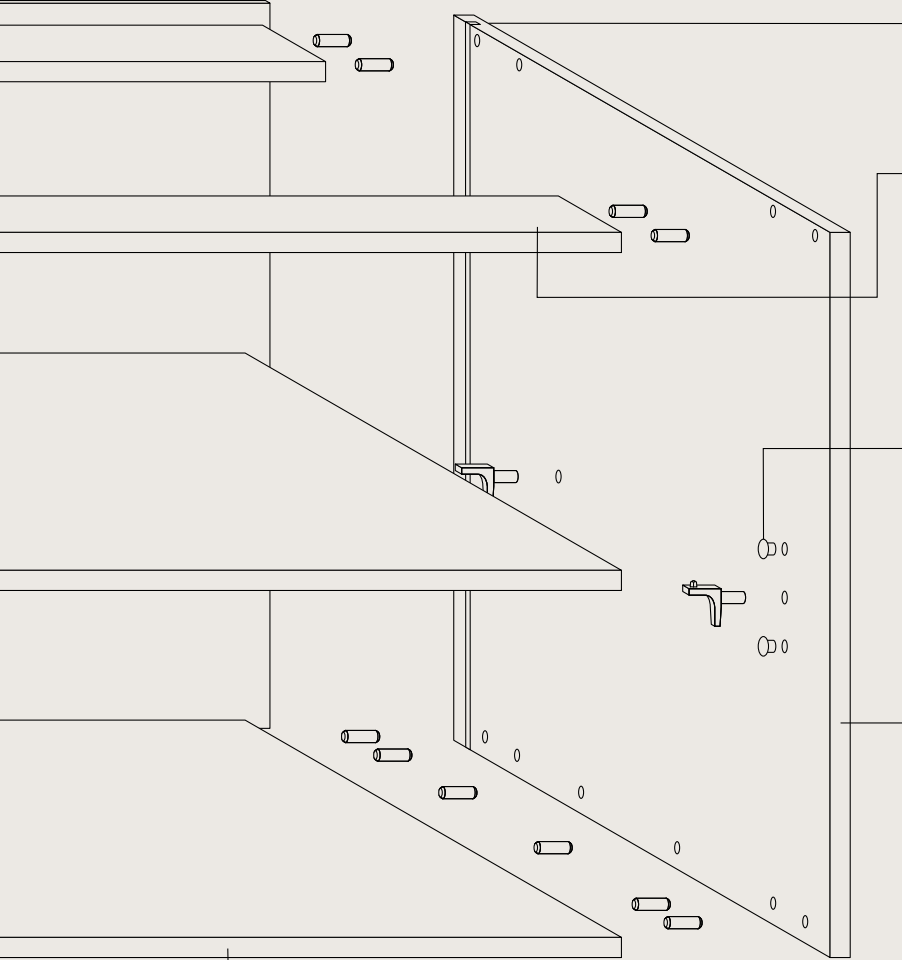

Offset back panels

- 2.8 mm thick HDF panel, both sides treated with protective lacquer
- Back panels are additionally screwed to the carcass, 7 mm deep slot
- Offset back panels ensure good air circulation between the wall and furniture
- The lacquer on both sides prevents the absorption of moisture and stops mould from growing
- No open joints in visible part of interior
- Lasting durability, yet adjustable for on-site assembly thanks to the screw connections

Construction shelves and cross-beams

- Extremely stable construction shelves and cross-beams with melamine resin coating on both sides: 19 mm for base and tall units
- Upper cross-beam for base units: neutral grey edge colour

Cover caps

- For an attractive unit interior design, it is possible to conceal the 5 mm drill holes with plastic cover caps
- Perfectly colour-coordinated with the carcass interior

Front edges

- Carcass front edges and shelves laminated with heavy-duty 1.2 mm PP edging: very robust and impact-resistant, with an aesthetically pleasing soft, rounded look

50 kg base support

- All bases, including shelves, can support weights up to 50 kg/m²
- That is the equivalent of more than 80 dinner plates

BASE UNITS: IT'S ALL ABOUT INNER VALUES

Our furniture boasts exceptional quality in every component. From the robust carcasses to the precisely coordinated details – every element has been developed with the utmost care. They meet the highest standards in terms of durability and convenience thanks to the high-quality materials and sophisticated design. Our base units are available with the carcass heights mini (576 mm), standard (720 mm), XL (792 mm) and maxi (864 mm) – for maximum flexibility and individual needs.

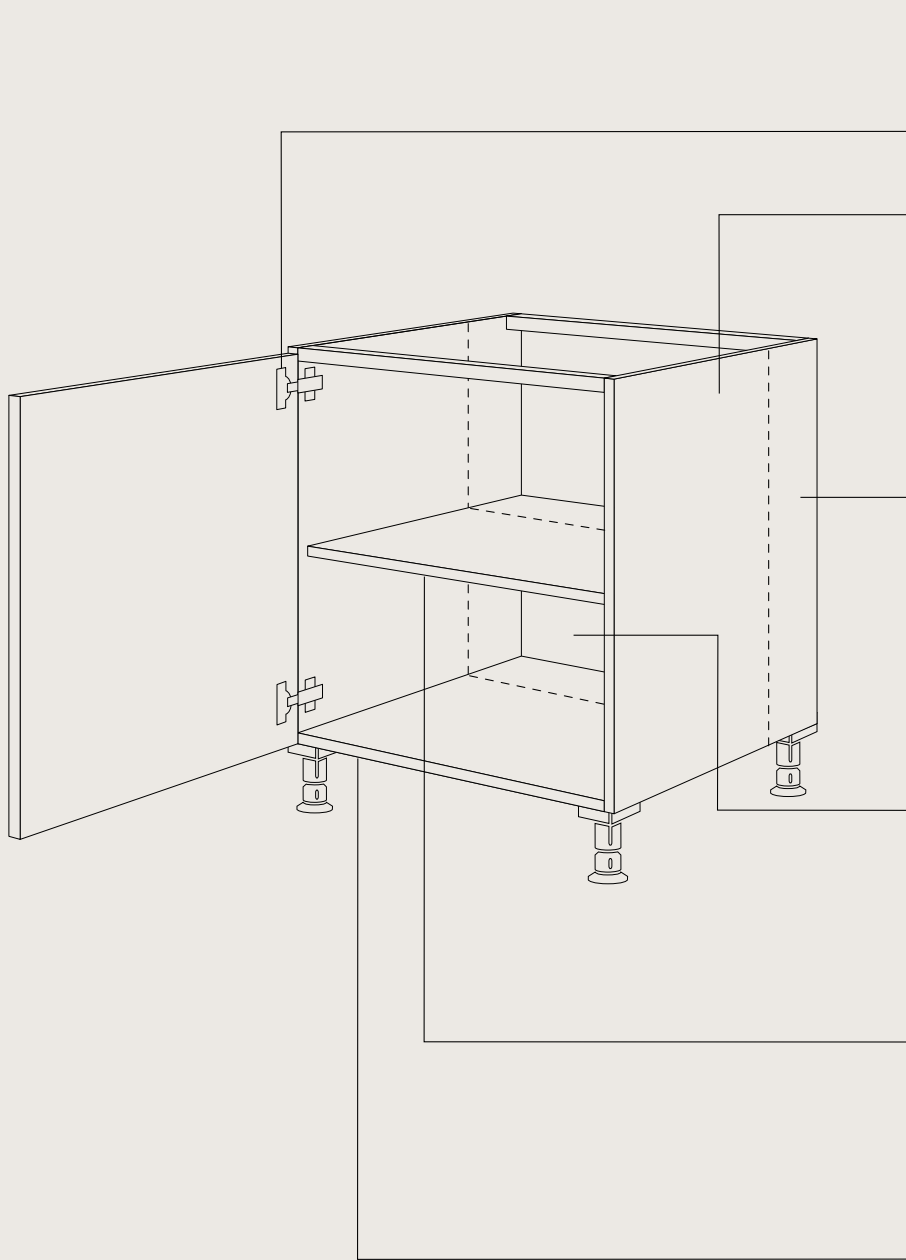

Sensys hinges

- With Silent System cushioning
- Adjustable in three dimensions
- Maintenance-free and easy to install

Carcass depth of 561 mm

- Carcass depth for base units: 561 mm
- Working depth: 522 mm
- Maintenance-free fittings
- Easy installation: drawers, pull-outs and hinged doors can be dismantled and reassembled without tools

Side depth of 461 mm for base units at no additional cost

- The 461 mm side depth allows customers to plan with confidence for designs involving narrow floor plans or for bathroom applications – with no additional costs for individual specifications

Back panels

- 2.8 mm thick HDF panel in grooved sides
- Lacquered on both sides
- Screwed to carcass

Shelves

- 16 mm thick shelves laminated with heavy-duty 1.2 mm PP edging
- Colour-coordinated with the selected carcass interior colour

Construction shelves

- 19 mm, secured to sides with dowels

ATTENTION TO QUALITY AND DETAIL



Stable metal cross-beams

- Our stove, sink and corner carousel units as well as 1,200 mm wide base units feature integrated metal cross-beams for exceptional stability
- Cooktop and hand basin units starting at widths of 800 mm are also equipped with reinforced metal cross-bars



Screwed-on back panels

- Offset back panels for optimal air circulation between the wall and kitchen furniture
- The sides with 7 mm deep grooves are additionally screwed to the carcass
- The back panels with protective lacquer on both sides enhance durability
- Galvanized metal coupling screws with pressed washers enable the secure connection of individual units



Modular corner base units

- Corner base units can be disassembled on-site (e.g. UEK 90)
- This allows them to fit through narrow stairwells and doors



Water-resistant bases

- The permanently installed, water-resistant grey metallic base for sink units and hand basin base units is available at an additional cost (MP-WPB)



Additional accessories for moisture protection

- The moisture protection base (FB) protects base units against moisture and scratches and can be retrofitted
- The slate grey water protection mat (WSMS) made of easy-to-clean plastic offers additional protection for sink base units and diagonal sink corner units without front pull-outs (side depth of 561 mm) and can be retrofitted



Steam protection plate dishwasher

- Tall units for raised dishwashers come with an extra-deep steam protection plate as standard
- The steam protection plate provides reliable protection against moisture and steam for lasting quality

TALL UNITS: ALL-ROUNDERS FOR STORAGE SPACE

With six carcass heights from 1,512 mm to 2,232 mm and a working depth of 522 mm, nobilia highboards and tall units provide optimal storage space for a variety of demands. Whether hinged doors, lifting doors, pull-outs, shelves, grids, baskets or flaps – our wide variety of cabinet elements enable functional and individual design.

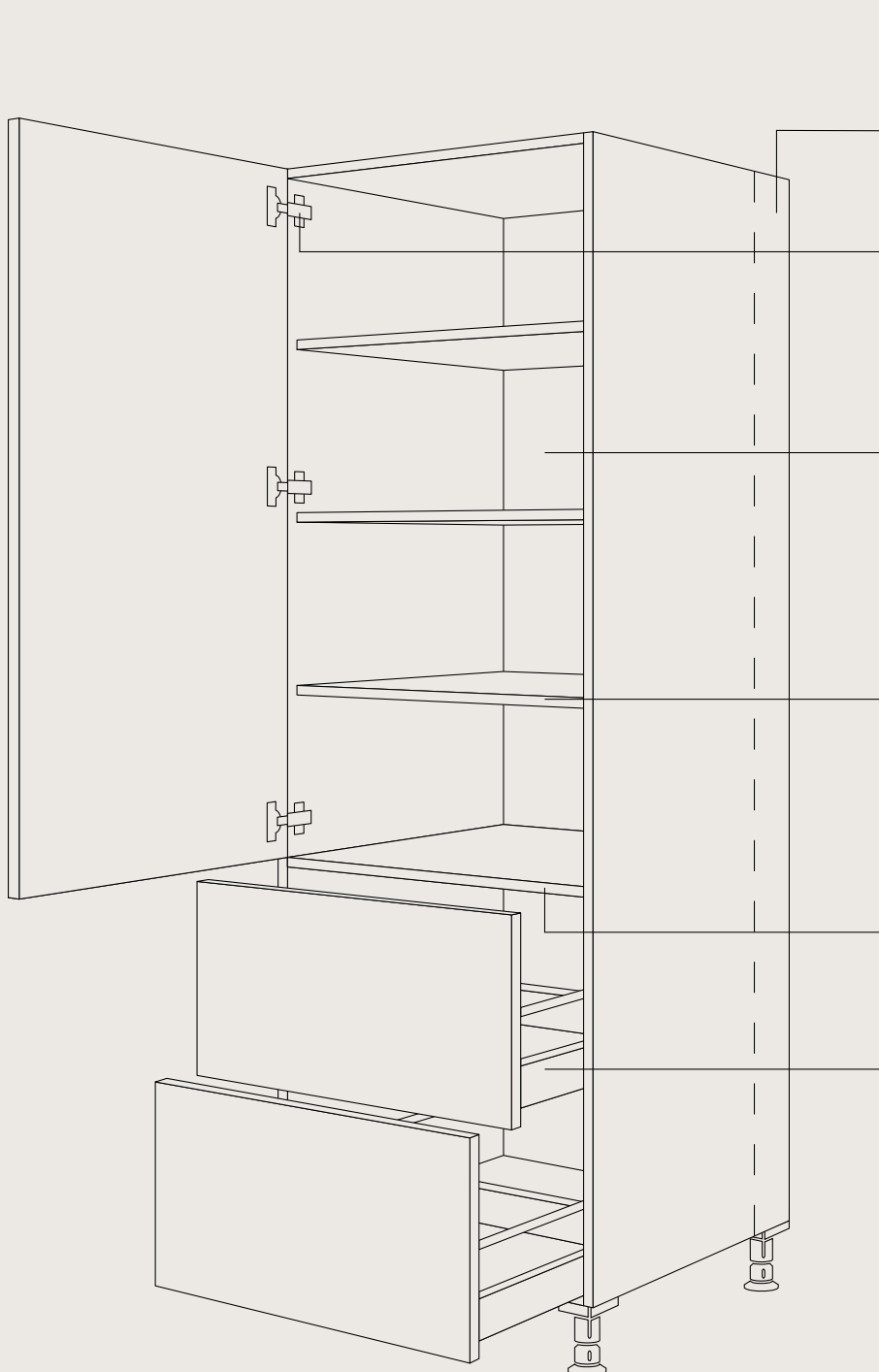

Carcass depth

- Carcase depth for tall units: 561 mm
- Working depth: 522 mm
- Side depth of 461 mm at no additional cost

Sensys hinges

- With Silent System cushioning
- Adjustable in three dimensions
- Maintenance-free and easy to install

Back panels

- 2.8 mm thick HDF panel in grooved sides
- Lacquered on both sides
- Screwed to carcass

Shelves

- 16 mm thick shelves laminated with heavy-duty 1.2 mm PP edging
- Colour-coordinated with the selected carcass interior colour

Construction shelves

- 19 mm, secured to sides with dowels

Storage space design

- Maximum space utilisation and various usages, for example as a tableware or supply cabinet or as appliance housing
- Various equipment options with drawers, interior pull-outs or lifting doors for maximum convenience

VERSATILE TALL UNIT SOLUTIONS



Continuous tall unit fronts

- We offer designs with continuous doors in all highboard and tall unit heights
- This creates a more harmonious, balanced look with monochrome and vertically grained wood décors
- The sales manual indicates which fronts are available as continuous tall unit fronts for each element



Tensioners

- All continuous tall unit doors with carcass heights of 2,016 mm to 2,232 mm (with the exception of pharmacy cabinets) come with a tensioner as standard
- The tensioner is positioned in the middle and stabilises the large front elements so they do not shift
- The tensioner (MP-SPANN, 7808) is optional for highboard heights



Appliance cabinets for built-in appliances

- Appliance housing for the integration of ovens, microwaves and refrigerators
- The raised installation position enables the ergonomic integration of appliances to reduce strain on the back



Appliance housing for washing machines and dryers

- TÜV-certified cabinet for raised washing machines and dryers
- The base is fitted with solid metal brackets for reinforcement so that the washing machine remains firmly in place even during spin cycles



Organisation systems

- nobilia offers a wide variety of tall units for a range of applications
- In addition to pre-configured tall units (see sales manual, section 6), individual organisation systems (see accessory list, section 3) can also be added to orders



Access doors

- Access doors can be used as connective elements between the kitchen and adjacent rooms. The entrance is discreetly concealed through the layout between the tall units
- For 600 mm width: one lug-connected door; for 800 – 1200 mm width: two lug-connected doors
- Consisting of two upright panels and one top shelf, 16 mm thick
- Including plinth panel with connection bracket

PLINTH FEET AND PANELS: THE PERFECT BASIS

Our plinth designs offer maximum flexibility and stability. With standard heights of 70, 100, 150 and 200 mm, which can be adjusted -10 to +20 mm, our plinth feet are perfect for a range of requirements. The plinth adapter allows intermediate heights to be achieved with ease. Because each plinth foot is independently adjustable, cabinets can always be made level, even on uneven tile flooring.

SOFA plinth adapter

- Intermediate, deviating plinth heights (in 10/20 mm grid) are possible with the SOFA plinth adapter (4187; see sales manual, section 3)



10 mm



20 mm

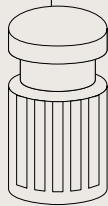

70 mm

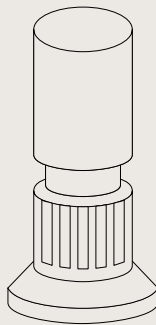

100 mm

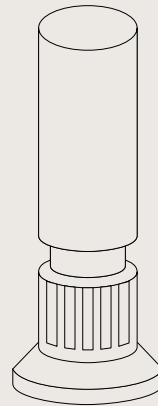

150 mm

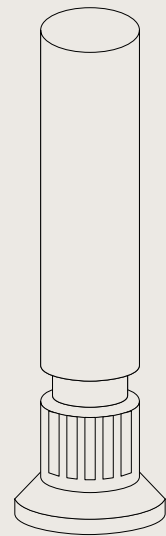

200 mm

Plinth feet

- Stable plinth design with adapters and feet
- Four standard heights: 70, 100, 150 and 200 mm
- Fine adjustments from -10 to +20 mm
- Plinth feet are independently adjustable – ideal for uneven tile flooring to ensure that cabinets are always level
- High load capacity: up to 200 kg per cabinet with four feet
- Also suitable for granite worktop

Plinth bracket

- The plinth bracket is securely bottom-mounted at the factory

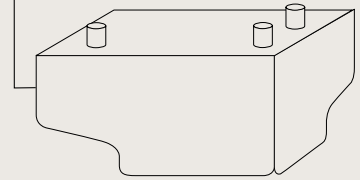

OPTIMALLY EQUIPPED



Plinth panel 13 mm

Plinth panels are made from 13 mm thick MDF (medium-density fibreboard) panels and are directly coated. This makes them extremely hard-wearing and low-maintenance.



Flexible base seal profile

Plinth panels with base seal profile protect the plinth area against moisture and dirt. The profile included compensates for unevenness up to 2 mm. The separate SB profile (4863) is needed if the unevenness exceeds this amount. Fine adjustment on uneven flooring is to be carried out upon installation. Exterior corners (90°/135°) and interior corners (135°) are formed by the relevant corner profile.



Side plinth panel additional 28 mm

To compensate for unevenness in the floor, 28 mm higher side plinth panels are provided. This allows adjustments to be easily made by the technician during installation. Clips are affixed or screwed to the panel and clipped onto the plinth bracket.



Water-resistant plinth panel

These are useful wherever there is a large amount of moisture or wetness and are also aesthetically pleasing. Water-resistant plinth panels are optional at an additional cost. Available colours: 058 black, 049 mirror décor, 114 stainless-steel look.



Aluminium slatted plinth

Not only is the aluminium slatted plinth a nice visual detail, it also enables air circulation within the plinth when used in conjunction with hot plate extractors. Available in all four plinth heights. Available colours: 114 stainless-steel look, 058 black, 193 alpine white.



KIPPS anti-tip safety brackets

Freestanding base units in island solutions always require KIPPS anti-tip safety brackets (9943). Two safety brackets are automatically included in orders of freestanding base units, with charges applied. Two safety brackets are required for widths up to 1,800 mm. Two additional safety brackets are required for each additional metre or part thereof.

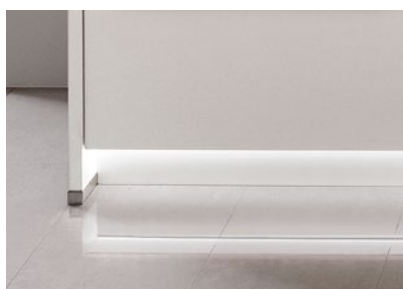

Plinth lighting

Plinth upgrade with modern lighting accents: the LSO LED plinth lighting, which can be installed individually, and the LSOP LED plinth lighting lend plinths a beautiful ambience.

WALL UNITS: STURDY AND VERSATILE

The nobilia wall unit offers both durable storage space and a wide selection of opening systems like hinged doors, sliding doors, folding doors, flaps, fold-and-lift doors, hinge-up flaps, roll-up fronts and climbers. The latter two styles, along with display cabinets and glass design units, open up further design possibilities with glass.

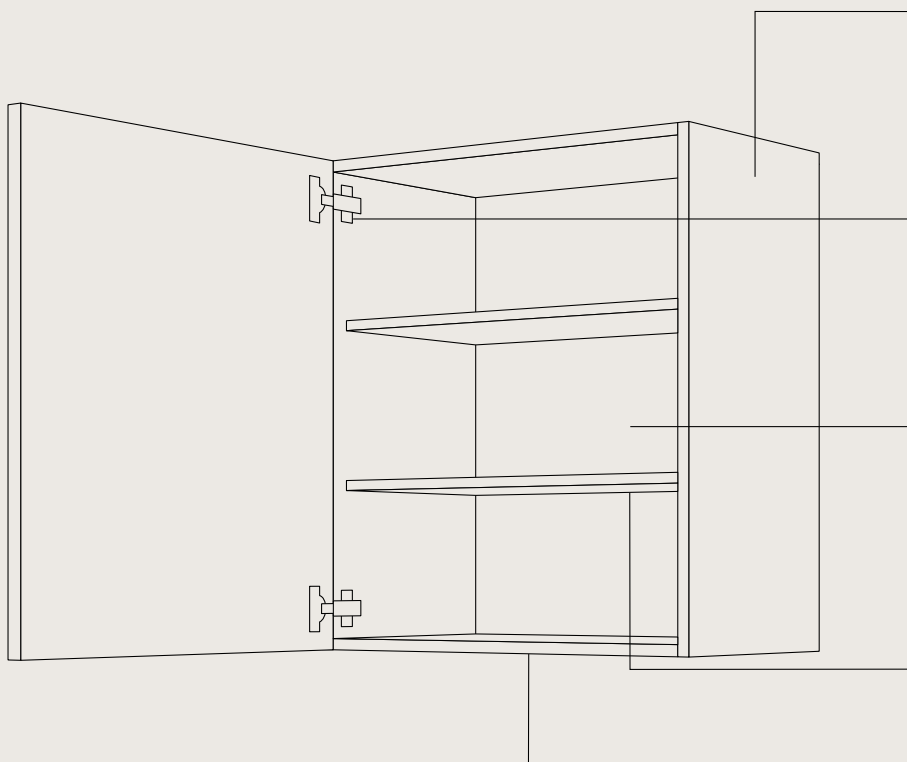

Carcase depth

- Carcase depth for wall units: 350 mm
- Working depth: 326 mm

Sensys hinges

- With Silent System cushioning
- Adjustable in three dimensions
- Maintenance-free and easy to install

Back panels

- 2.8 mm thick HDF panel in grooved sides
- Lacquered on both sides
- Screwed to carcase

Shelves

- 16 mm thick shelves laminated with heavy-duty 1.2 mm PP edging
- Colour-coordinated with the selected carcase interior colour
- Load capacity per shelf: 16 kg

Construction shelves

- 16 mm, secured to sides with dowels

AN EXTRA TOUCH OF QUALITY



- Secure installation on various types of walls thanks to special fittings
- Versatile opening systems: hinged doors, sliding doors, folding doors, flaps, fold-and-lift doors, hinge-up flaps, roll-up fronts and climbers
- Numerous design options – for example for display cabinets and glass design units
- Unevenness is easily compensated with spacer panels
- Soft closure of all doors and flaps
- Integrated lighting for additional functionality and atmosphere possible
- All wall units have been tested in nobilia's QM lab to ensure a service life of at least 15 years

WALL UNIT MOUNT: AN EXTRA TOUCH OF STABILITY AND SAFETY

Secure and stable installation in lattice stone, sand-lime brick and concrete is ensured. Elements for bathroom and living room designs with a depth of 461 mm are equipped with a heavy-duty fitting for wall-mounting as standard.



Wall unit rails

- Mounting rails included: from widths from 590 mm with four screws and dowel for the most secure mount
- Spacer panels to compensate for wall protrusions included

Concealed wall unit mount

- Concealed wall unit mount with convenient height (-7 and +10 mm) and depth (-1 and +11 mm) adjustment
- Maximum safety: Anti-tip safety brackets to prevent against lateral sliding are automatically confirmed with the order at no additional charge

Bridging units for freestanding refrigerators

- Bridging units are available to make the most out of the available space above freestanding refrigerators. Range of elements: widths of 600 – 1,200 mm, heights of 288 – 720 mm, depth of 561 mm
- For floating designs, the required assembly sets are automatically confirmed, with charges applied. More information can be found in the sales manual, section 10

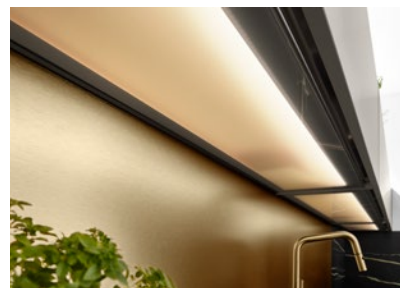

1,200 mm wide wall units

- The extra-wide wall unit comes with a handle profile on the bottom shelf as standard to prevent buckling
- The back panel features a middle hook and a third wall unit mount
- An additional bracket supports the shelves and prevents them from buckling
- The construction offers high stability and safety with a load capacity of up to 75 kg

Glass doors

- Smooth fronts are available as an option with glass frame doors and segmented glass fronts. Designs: 01 clear glass, 02 matte glass, 39 black glass
- Country house fronts feature straight-framed doors with set-specific glass designs
- In addition to the front-specific display cabinets, design glass doors are also available: square and flat aluminium-framed doors with a variety of glass designs; see sales manual, section 2

Integrated lighting designs

- Wall units can be pre-fabricated with integrated lighting designs on the top and bottom shelves
- LED glass light shelves, integrated LED strips and LED plant lights are available at an additional cost
- Additional options for selected lighting designs: emotion ambience technology for infinitely adjustable colour temperature, from warm white to cold white, as well as Philips Hue with White & Colour Ambiance

STATE-OF-THE-ART LIGHTING TECHNOLOGY

At the cutting edge of modern lighting technology: energy-efficient LEDs can be recessed or surface-mounted, integrated into mirrors, or provided as a Philips Hue smart-home-compatible lighting solution. Many of our solutions enable custom colour temperatures and a range of lighting scenarios – from emotional ambience to functional work lighting. These solutions are complemented by innovative electrification solutions and clever products for secure cable management.



LED LIGHTING



Emotion technology

- Emotion technology enables the infinite adjustment of colour temperature in LED systems, from warm white (2,700 K) to cold white (6,500 K)
- ZigBee enables all custom lighting designs with LSET-SMART* to be integrated into smart home applications
- Each lighting group requires at least one LSET-SMART36/60(-FB), matched to the slots and total power of the lights
- Multiple starter sets can be connected wirelessly and linked in by a four-channel remote control
- Light source control across multiple rooms



Illuminated mirrors

- From surface-mounted lights to integrated light windows and all-round profiles, nobilia offers a wide selection of mirrors with clever LED lighting for the ideal lighting ambience in the bathroom
- More information on illuminated mirrors can be found in the accessory list, section 5



Philips Hue

- Smart lighting solutions that can be controlled via Bluetooth, remote control or app
- For additional smart home features, the Philips Hue Bridge allows up to 50 lights in different rooms to be controlled via app, voice command, timer and even from on the go



Philips Hue – White & Colour Ambiance

- In addition to warm white and cold white lighting, a number of pre-set lighting scenarios and 16 million colours are also available
- LED starter sets (LSET-HA60) and LED extension sets (LFSET-HA60) available at an additional cost, see accessory list, section 4

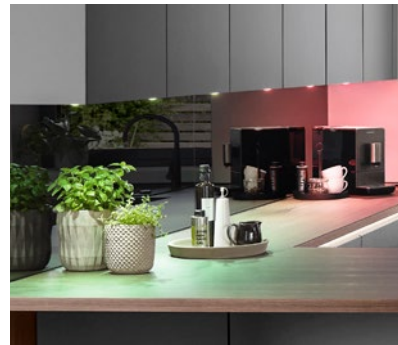

Philips Hue – Gradient

- The Gradient LNHLG-E creates a colour gradient along the entire length of the light
- Several colours are combined simultaneously within the light
- The minimum recommended length of the light is 600 mm

CABLE BOXES FOR SECURE CABLE MANAGEMENT



Cable box

- Slate grey plastic housing for converters and connection cables
- For individual assembly in cabinets
- Available starting at a width of 450 mm, for vertical assemblies from a width of 250 mm



Cable and transformer box

- Cable and transformer box in neutral grey plastic housing for a maximum of four converters and connection cables
- For installation in the plinth base
- Available starting at a plinth height of 70 mm and a cabinet width of 600 mm

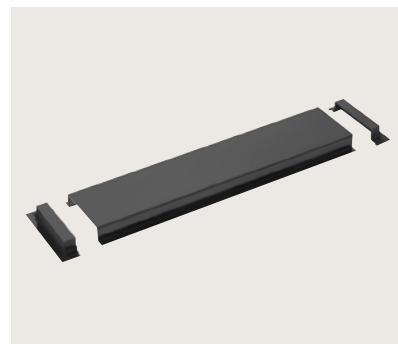

Glasgow security box

- The Glasgow security box (SIBOX) protects sensitive electronics like the LED converter from the LED starter and extension sets
- LSET-SMART36/60 and LSET-SMART36/60-FB
- Electrical components for bathroom applications must comply with IP44 certification requirements for splash protection
- SIBOX features: splash-proof according to IP44, black aluminium housing, including end caps for easy connection, dimensions: 19 x 453 x 103 mm

LIGHTING OPTIONS FOR WORK LIGHTS

Bright, focussed light! In addition to being visually appealing, integrated and surface-mounted lights, niche lights, long-field lights, and ceiling lights solve an important design problem: even, glare-free lighting in work areas and active zones.



Integrated and surface-mounted lights

Our integrated and surface-mounted LEDs can be installed on both the top and bottom shelves. For installation in glass wall units, cornices and bridging shelves. Available in a stainless-steel look with a diameter of 75 mm; starter sets include 1,700 mm of connection cable. Also available as LED set with three LEDs and one Emotion Dimmer LED starter set.



Niche lighting

Niche lighting in rectangular, round or pyramid-shaped designs as linear lights, surface lights and long-field lights: they ensure even niche lighting and are ideal for installation beneath wall units.



Ceiling lights

iLand ceiling lighting combines indirect and direct light. The indirect light portion ensures a pleasant ambience through reflections on the ceiling, while the direct light portion creates bright, even, glare-free work lighting, for example for kitchen islands. Both types of light can be independently controlled and dimmed.

LIGHTING OPTIONS FOR AMBIENT LIGHTS

We offer high-end, flexible ambient LED lighting with state-of-the-art technology that generates a pleasant ambience and appealing aesthetic.



LED shelf unit lighting

The individual shelves of open shelving units can be equipped with an LED light strip. This allows for individual, focussed lighting accents.



LED glass edge lighting

The LED glass edge lighting of the 8 mm thick glass shelf combines furniture and lighting. Available for wall units with glass doors with widths of 450, 500 and 600 mm and a depth of 305 mm. Available for wall units with glass hinge-up flaps or glass fold-and-lift doors in widths of 500 – 1,200 mm and a depth of 278 mm.



LED interior unit lighting

The LED interior unit lighting includes an integrated sensor switch and is available for unit widths of 300 to 1,200 mm.

ELECTRIFICATION

Modern living spaces require clever electrification concepts that combine functionality and design. nobilia allows power sockets and connections to be flexibly placed where they are needed – in worktops, bar consoles, niches and mirror cabinets. An overview of all power socket designs can be found in our accessory list at section 2.



Integrated power sockets for worktops

Our modern integrated power sockets provide functional and elegant solutions for worktops. With a USB charger, touch protection and an inductive charging station, they integrate seamlessly into the kitchen environment. Models with rotatable cover plate or recessed power sockets enable flexible and subtle integration.



Power sockets for niches

Niche power sockets are especially practical as they are located directly at the worktop. Corresponding modifications of niche carcass material can be made during installation. Glass, mirror, quartz and Xtra Ceramic niches are also customisable. Precise cut-outs for power sockets are available at an additional cost.



Integrated power sockets in bar consoles

With integrated power sockets with touch protection, bar consoles offer additional functionality in the kitchen. They are especially practical for plugging in kitchen appliances, tablets and more.



Power sockets for mirror cabinets

Double power sockets with touch protection, a plastic housing and IP44 safety certification. Available for Type F, Type E and Type J (without touch protection) power sockets.



Cable apertures

From worktops to media panels: the cable aperture hides all cables from view, making it easier to use your electronic devices. A modern solution that perfectly combines convenience, design and organisation.



Country types

Electrical accessories and furniture items are primarily approved for the EU and the European Economic Area (EEA: EU + Norway, Liechtenstein, Iceland). An overview of available power socket types can be found in the accessory list, section 2.

PROVEN SOLUTIONS FOR EVERY ROOM

We apply our years of experience and proven quality in kitchen production to our living room and bathroom furniture down to the last detail. The versatile nobilia range offers high-quality furniture and components that have been tested according to strict standards for every room. Many of these items are TÜV-certified for tested safety (GS) – top product quality for the entire living environment.

Flexible modular design Product characteristics for living rooms and bathrooms



AN EXTRA TOUCH OF QUALITY



- Well-designed product lines and planning suggestions for easy and safe implementation

Living room

- Coffee tables with metal frames made of top-quality steel for high level of robustness
- Scratch-resistant, powder-structured surface in black
- Tautly upholstered seats for optimal comfort
- Durable, wear-resistant upholstery material
- Entertainment centres, cabinets, tables: extra variety for your living room

Bathroom

- Wall-hung furniture with heavy-duty fittings (up to 100 kg)
- Moisture protection through offset back panel and water-resistant shelves
- Built-in and furniture hand basins as well as surface-mounted sinks made of high-quality materials like ceramic, mineral composite and quartz



www.tuv.com
ID 111120658

PRODUCT AND QUALITY FEATURES ESPECIALLY FOR LIVING SPACES



Coffee tables

- A variety of models with choice of frame and top shelf for individual designs that match any interior.
- Frame made of high-end steel for excellent robustness and durability
- The powdered-steel or powder-textured surface in black makes these frames exceptionally resistant to wear and scratches
- Available designs:
Top shelf for Dublin coffee table: 16, 25 or 50 mm thick; top shelf for Dakar coffee table: 16 or 25 mm thick



Table frames for dining tables

- Four frame designs in black from high-end powder-coated steel
- TÜV-certified: GS seal for safety and quality standards
- 24 mm thick tabletop extendible without tools
- Depending on frame model, with front-slide, synchro-front-slide or synchro-middle-slide pull-out and two 500 mm attachable wings
- The tables are 950 mm wide and 760 mm tall



Upholstery for dining room chairs

- High-end upholstery: tautly upholstered seats minimise wave formation and ensure maximum comfort while seated. Our upholstery fabrics are also tested for pilling resistance and lightfastness
- Fabric options – durable, with tested abrasion resistance.
Vintage velours: extremely wear-resistant, with 100,000 abrasion cycles; vegan leather (100% polyester): water-resistant and durable, with 50,000 abrasion cycles



Entertainment centres

- Offer space for hi-fi systems and soundbars
- Recessed back panel with cable routing and cable aperture
- Media panel can be combined with base unit or entertainment centre
- Reinforced design for TVs with swivel arms enables wall-mounting
- MP-MEDIPL ambient lighting optional
- More information can be found in the sales manual, section 9



More variety

- Our expertise in the field of kitchen furniture enables us to offer a variety of clever, already proven solutions for other rooms as well – from cutlery inserts to design shelves Taro
- The uniform carcass grid in 72 mm increments simplifies planning with harmonious lines, regardless of the room it is intended for



Siphon cut-outs

Pull-outs and drawers in hand basin units feature a wooden back panel into which cut-outs for siphons can be flexibly made during installation. At an additional cost (SIA1WT/ SIA2WT), siphon cut-outs can also be pre-fabricated (in the middle only). Cut-outs for two siphons can also be made in base units with a width of 1,200 mm. The water-resistant plastic cover included protects the siphon cut-out and is screwed directly onto the cut edge – no tape necessary (see bathroom sales manual, S. B 0.10).



Brand-name ceramic hand basins

nobilia offers a broad selection of built-in and furniture hand basins as well as surface-mounted sinks. The surfaces feature an impressive variety of high-end materials like ceramic, mineral composite and Duratek®. Many brand-name ceramic hand basins outside of the nobilia range are also compatible with the BWSAM hand basin unit. A matching hand basin can be selected from the overview in the hand basin and bathroom fitting section of the accessory list. The cabinet will then be configured according to the specifications given upon ordering. More details can be found in the accessory list, section 6.



Accessories for hand basins without an overflow

For hand basins without an overflow, the Clou drainage and overflow system presents a space-saving solution. It is installed out of sight behind or beneath the hand basin and serves as the overflow mechanism. A non-closable drain (permanent valve 17710/17732) that offers reliable protection against overflowing is available for thin-panelled hand basins that do not offer enough space for Clou systems.



Mirrored doors

Our double-mirrored doors represent the highest quality and design standards. Unlike many traditional solutions with support panels, we offer a premium product as standard that stands out considerably from most bathroom solutions – with first-rate functionality and aesthetics. A profile strip with a stainless-steel look is integrated into the bottom shelf of the wall unit. One handle is included per door for optional installation.



Water-resistant bases

For additional moisture protection, bathroom units and sink units can be equipped with a waterproof base (MP-WPB) in grey metallic at an additional cost.



Back panels

No moist spots, no mould: optimal air circulation is essential in the bathroom, and offset back panels make this possible. Back panels with lacquer on both sides and all-round sealed shelf edges offer additional protection and guarantee lasting quality.



Stable heavy-duty fittings

Wall-hung bathroom furniture like base units, sideboards and midi units are equipped with heavy-duty fittings that can be installed in lattice stone, sand-lime brick and or concrete.



Metal cross-beams

Our hand basin units designed for built-in or surface-mounted hand basins come with metal cross-beams as standard. These prevent buckling and offer additional stability.



Wall-hung base units with side depth of 561 mm

Base units with a side depth of 561 mm, including a support bracket (MP-BUST), are available at an additional cost for selected elements. Free-hanging solutions without support brackets are not permitted. Detailed information can be found in the bathroom sales manual, section 2.

PERFECTION TO THE CORE

Every detail counts – our furniture interiors combine precision, quality and innovative technology with maximum convenience.



nBOX DRAWER SYSTEM

Premium design and technology as standard. The innovative nBOX system boasts a minimalist, rectangular look and narrow frame measuring just 10.7 mm. The concealed drawer guide and optional push-to-open function leave nothing to be desired in terms of convenience and technology. Individual design options such as design covers and design profiles make the nBOX the ideal solution for holistic kitchen, bathroom and living room planning.



FUNCTIONAL FITTINGS

High-quality, stable and durable – functional fittings like our swivel pull-outs, pharmacy cabinets and corner unit solutions are impressive with their high durability and smooth, elegant motion. They ensure optimal quality and make everyday life more convenient.



SENSYS HINGE TECHNOLOGY

Perfect cushioning, perfect design: our hinged doors come with Sensys hinges as standard. The Silent System cushioning is integrated into the hinge, out of sight. The large hinge angle of 35° enables the doors to be shut gently and reliably.



FLAP SYSTEMS

Whether folding, swivelling, lifting or tilting: innovative fitting systems ensure that even heavy wall unit flaps can be opened with ease and stay open in any position – for convenient use without restrictions. Fold-and-lift doors and hinge-up flaps are available with ServoDrive electrical motion assistance upon request.

nBOX – SETTING STANDARDS IN INNOVATION AND DESIGN

The exclusive nBOX drawer and pull-out system is a proprietary development and offers premium design and technology as standard. With an ultra narrow frame, concealed drawer guides and the optional push-to-open function, the nBOX combines convenient functional versatility with innovative technology. The nBOX also offers flexible design at the highest level.



INNOVATION MEETS DESIGN

Thanks to the design's structural clarity, the nBOX is perfect for the kitchen, bathroom and living room and serves as the connecting link between rooms.



Filigree frames

With a frame with a thickness of just 10.7 mm, the nBOX combines a narrow and modern design idiom with high stability. The filigree, minimalist look integrates perfectly into the overall room aesthetic.



Concealed technology

The concealed drawer guides are installed out of sight under the ultra narrow frame with maximum precision.



Push-to-open

The nBOX drawer system is an attractive option with its perfect cushioning and self-closing mechanism. nBOX drawers and pull-outs are push-to-open-compatible for an extra touch of convenience and functionality. The perfect solution for handleless designs.



Slate grey aesthetics

The sophisticated slate grey, which can also be integrated in the carcass interior upon request, characterises our entire pull-out system and interior. As a functional link between rooms, the nBOX follows the “more than kitchen” approach of our range and is ideal for consistent design in the kitchen, bathroom and living room.

FUNCTIONALITY AND CONVENIENCE TO MEET THE HIGHEST NEEDS

Cleverly designed down to the smallest components: the nBOX offers compact, state-of-the-art technology with maximum precision.

More storage space

The combination of the narrow frame shape and underside rail enables optimal space utilisation.

Perfect gliding

The innovative rail ensures exceptional gliding and side stability – even with heavy loads.



Total load capacity of up to 70 kg

Thanks to its high load capacity, the nBOX is not just aesthetically pleasing but also boasts impressive everyday practicality.

Easy adjustments

Perfect alignment with convenient tilt adjustment.

Push-to-open

With the optional push-to-open function, the nBOX offers the perfect solution for handleless designs.

Concealed technology

The concealed drawer guides are installed out of sight under the ultra narrow frame with maximum precision.

THE SYSTEM

With a square railing, optionally with a grey glass side or as a closed pull-out box, the nBOX system can be customised to meet customers' needs. Interior drawers and pull-outs can also be customised in the front.

Equipment options can be indicated as set-related information for the entire commission. Detailed information can be found in our sales manual, section 0.



Series standard

The pull-out is equipped with a square railing as standard.



Pull-out with railing and glass side

Pull-out with grey glass insert (8 mm, tempered). Additional charges apply for each (interior) pull-out (MP-GLAS 7915).



Pull-out box with closed side

Stable quality: the closed side consists of continuous, tall frame. Additional charges apply for each (interior) pull-out (MP-GLAS 7905).



Wooden panel

Standard for interior drawers and interior pullouts.



Design glass panel

Optional at an additional cost (MP-DGBLEN 7925).



Plastic design panel

Optional at an additional cost (MP-DBLEN 7935).

CUSTOMISATION OPTIONS

Whether as an accent or a completely new look: design profiles and design covers enable a variety of design options. All covers and profiles can be clipped onto the frame and swapped out by hand without tools. Additional charges apply for each (interior) drawer and (interior) pull-out. Additional fees can be added to the set-specific order information upon placing the order for seamless processing.



Design profiles

The fine plastic profiles can be indicated directly upon placing the order or ordered separately as an accessory (MP-DPRO 7918). Suitable for all (interior) drawers and (interior) pull-outs. Depths: 300, 400, 500 mm. It is not possible to combine with the design cover.

Design covers

The high-quality aluminium covers can be indicated directly upon placing the order or ordered separately as an accessory (MP-DCOV 7923). Not suitable for (interior) pull-outs with glass side (MP-GLAS) or for low frames (MP-NIEZA). The covers are available in two different heights that are suitable for drawer and pull-out frames.

Learn more about the colours available, watch in-depth videos and discover a variety of design examples.

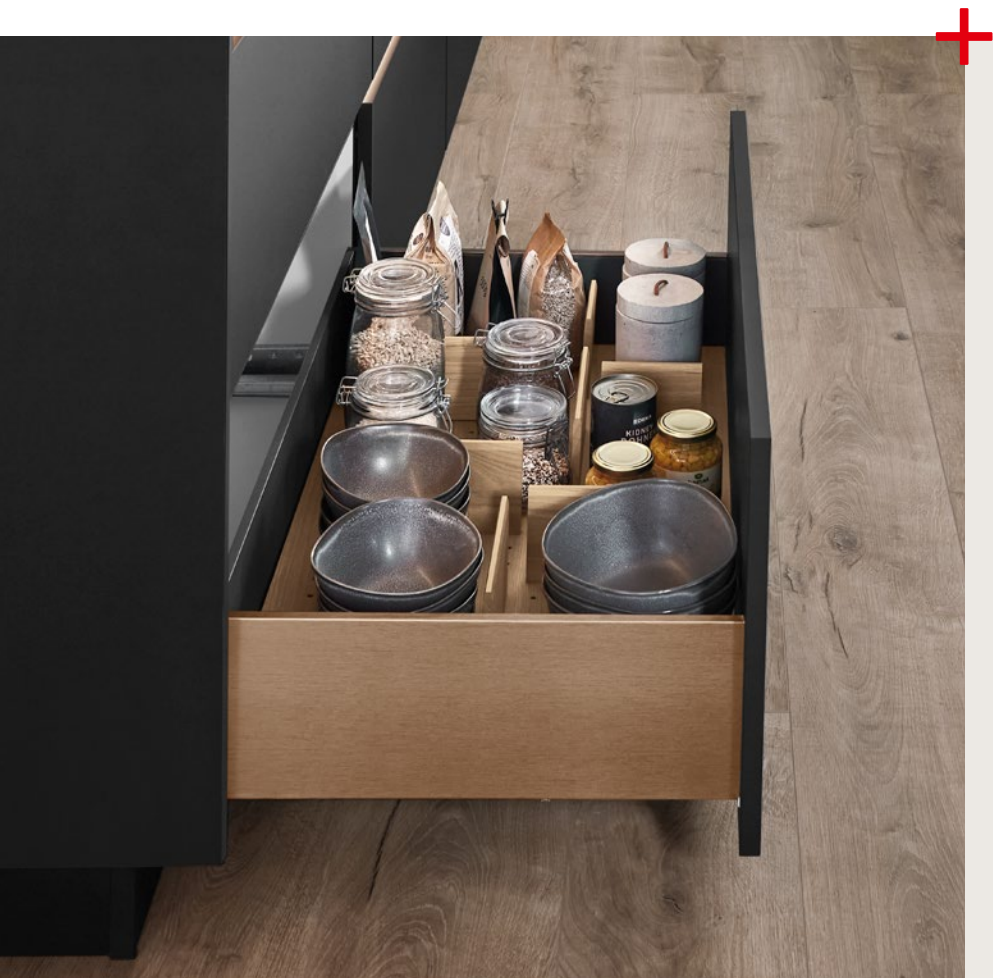

AN EXTRA TOUCH OF QUALITY



- Optimal space usage thanks to straight frame shape and underside guide beneath the drawer
- Excellent gliding and side stability
- Perfect cushioning behaviour
- Numerous design and customisation options
- Comprehensive look on shape and colour for drawers, pull-outs and interiors
- One system for kitchen, bathroom and living room applications
- The nBOX's easy adjustment capabilities ensure perfect alignment thanks to the convenient tilt mechanism
- The nBOX offers premium design and technology at attractive prices as standard

STRONG FUNCTIONAL FITTINGS

Solid and strong! Cabinets, drawers and pull-outs are subject to everyday wear and tear, which is why these have been made according to the latest technological standards. They fulfil all applicable standards, such as DIN 68930.

Robust functional fittings enable convenient and secure use and ensure a high load capacity – tested and certified by external specialists as well as at nobilia's QM lab according to additional standards. Integrated cushioning systems enable doors to be closed gently and silently and offer maximum convenience of use.



AN EXTRA TOUCH OF QUALITY



- Functional fittings have been tested in nobilia's QM lab to ensure a service life of at least 15 years
- Your customers will benefit from robust fittings that maintain flawless functionality even with daily use thanks to their excellent quality, making them exceptionally durable
- High load capacity: loads of up to 80 kg are possible, depending on the functional fitting
- The push-to-open mechanical opening system can be ordered with drawers, pull-outs and the Junior pharmacy cabinet as an optional feature
- Cargo and pharmacy tall units are also compatible with eTouch electric opening assistance
- Cushioning mechanisms enable the functional fittings to be closed gently
- Intelligent lift and swivel mechanisms provide ease of access, even in difficult-to-reach areas
- Metal boxes include anti-slip mats
- The high quality of the functional fittings also makes them visually appealing: the colour and geometry perfectly match the nBOX and interior accessories

FUNCTIONAL FITTINGS



Cargo tall units

The metal boxes of the Cargo supply cabinet slide out upon opening the hinged door for convenient access to its contents. Cargo tall units with eTouch are available for handleless designs. Standard equipment: four or five metal boxes with anti-slip mats, height-adjustable.



Corner unit solutions

nobilia corner units enable you to make the most out of your storage space, even in corners, ensuring easy access and personal convenience. Carousel and swivel pull-out units have a maximum load capacity of 20 kg per shelf.

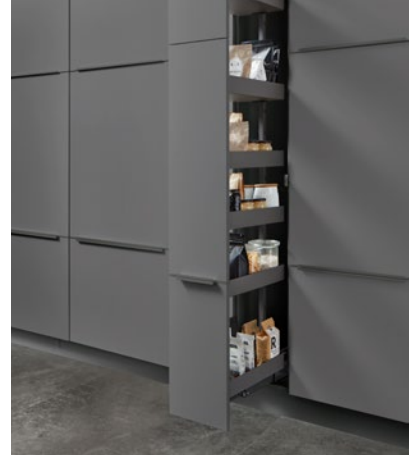

Pharmacy pull-outs

The pharmacy pull-out with SoftStoppPro cushioned opening and closing slides quietly into and out of the carcass until the motion is gently damped. Available with eTouch* for handleless designs. Standard equipment: five or six metal boxes, including anti-slip mats. Maximum load capacity of 80 kg.



300 mm wide pull-out units

The various available versions of our pull-out units enable more clever, versatile use of storage space: available with interior drawers and removable metal bottle basket, as a recycling receptacle, with dividers for a baguette bag and four bottles, or as a base unit with the Junior pharmacy pull-out and two adjustable metal boxes (anti-slip mat included).



150 mm wide pull-out units

High-quality full pull-out, featuring cushioned opening and closing (soft close). With a width of just 150 mm, they allow optimal use of even the narrowest spaces. A variety of versions are available – with towel holder, baking sheet holder or two practical metal baskets. Anti-slip mats included.



Optional opening systems for handleless designs

- MP-PTOSA mechanical opening system for hinged doors, drawers, pull-outs and Junior pharmacy cabinet functional fittings
- eTouch electric opening assistance for pharmacy and Cargo tall units
- MP-EASYS electromechanical opening system for fridge-freezers integrated into tall units



SENSYS: PERFECT CUSHIONING, PERFECT DESIGN

The multiple-award-winning Sensys hinge with invisible integrated Silent System cushioning by Hettich features a remarkable opening angle of 35° for an exclusive closing experience – soft, gentle and quiet. State-of-the-art technology with exceptional value for money: all nobilia cabinet elements come with Sensys as standard at no additional cost – from the entry level to the more upscale price range.

FEATURES

The advantages of Sensys hinges are impressive: with at least 80,000 cycles tested, Sensys represents maximum reliability and everyday practicality.



Excellent cushioning

Sensys hinges come with the integrated Silent System cushioning system as standard. Sensys provides absolutely reliable cushioning even for various door sizes and weights.



Convenient closing

The doors close shut evenly and silently via the slightest movement of the wrist. The automatic self-closing mechanism ensures secure closing starting at a hinge angle of 35°.



Reliable quality

Sensys ensures even and gentle closing in a remarkably high temperature range of +5°C to +40°C and with a relative humidity of up to 90%.



Door buffers

Additional noise damping: all nobilia fronts come with 2 mm thick plastic buffers on the inside of the doors for further cushioning as standard.

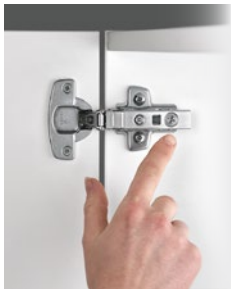

Tool-free assembly

Convenient clip function. Assembly and disassembly can be carried out quickly and easily without the use of tools by simply pressing on the discreet unlocking button.



Perfect alignment thanks to easy adjustment capabilities

The hinges allow the depth to be adjusted directly and offer optimised height and depth control.

HINGE TYPES



110° door hinge

Hinged doors are equipped with 110° hinges featuring integrated cushioning as standard. The large opening angle enables convenient access to even the deepest corners.



95° hinge for diagonal wall corner units

Ideal for diagonal wall corner units and therefore in keeping with the nobilia standard: the limited opening angle prevents the handle from hitting adjacent cabinets.

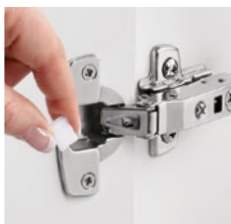

85° opening angle limiter

Reducing the opening angle of 95° and 110° hinges protects the front from damage and increases safety for corner solutions, wall connections and glass doors next to the extractor hood. Quick and easy installation.

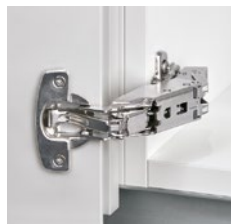
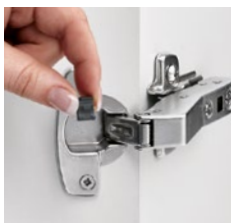

165° wide-angle hinge

Corner base units, wall corner units and cabinets with interior pull-outs are pre-fabricated with 165° wide-angle hinges. Adjustable opening angle limiter (to 90°/135°) are included as standard. Installation next to upright panels is possible, but not next to very deep or offset cabinets.



AN EXTRA TOUCH OF QUALITY



- Perfect edges and radii for exceptional design quality, distinguished with the Red Dot Design Award and the iF Product Design Award
- Gentle and quiet: high-quality Silent System cushioning system, invisibly integrated into the hinge arm
- Exclusive closing experience thanks to automatic self-closing mechanism from a hinge angle of 35°
- Durability tested with over 80,000 cycles, full functionality in a temperature range from +5°C to +40°C
- Tool-free clip function for quick and secure installation
- Adjustable in three dimensions for perfect alignment, even for thick doors with small radii
- 110°, 95° and 165° hinges with optional opening angle limiter provide solutions for every application

GREAT EASE OF MOVEMENT, GREAT VARIETY

With flaps, fold-and-lift doors, hinge-up flaps, sliding doors and slatted glass fronts, nobilia offers a versatile range of alternatives to hinged doors. For example, AVENTOS fittings enable ease of movement for even large and heavy flaps without compromising freedom of movement or headroom. All flaps shut gently and quietly, no matter how hard they are closed. The power storage integrated into the hinge is precisely adapted to the weight of the front, ensuring that the flap is held open securely in any position and can be easily closed.



AVENTOS FLAP SYSTEMS



Flap

- Ideal for medium-sized and small flaps on wall, dresser and tall units
- The flap movement requires only minimal overhead space
- Carcase height: 360 mm
- Opening angle: 107°



Folding/lifting door

- Fold-and-lift door, idea for high wall units: easily reachable handle, even when the flap is opened
- Two-piece front for minimal space requirement, even with large carcase heights
- Intermediate hinge prevents fingers from getting pinched
- Carcase heights: 576, 720, 792 mm
- Optional ServoDrive equipment (MP-SD) available at additional cost



Swivel flap door

- Ideal for large, one-piece fronts
- Minimal space requirement thanks to swivel movement
- Carcase height: 720 mm
- Optional ServoDrive equipment (MP-SD) available at additional cost



Folding door with sliding technology

- Ideal for narrow kitchens as the swivel feature halves the door's opening radius
- The fold-and-slide door utilises sliding technology on the top shelf
- Only for 600 mm wide wall units



Sliding doors

- Wall unit system with sliding doors in heights of 360 and 720 mm
- Space-saving as the doors do not extend into the room (the front protrudes an additional 8 mm compared to other wall units)
- Customisable with a wall unit carcass, sliding door in the original front, or glass frame design and a track profile set (adjustable during installation, 2,500/4,000 mm)



Climber wall unit with slatted glass front

- The climber wall unit with mechanical or electric slatted glass front offers maximum convenience in three glass colours
- With the electric version, the glass slats can be opened and closed automatically via touch control



AN EXTRA TOUCH OF QUALITY



- Flaps, folding/lifting doors, swivel flap door, folding doors, wall units with slatted glass fronts and cabinets with roll-up fronts enable effortless opening and closing and more headroom
- Sliding doors, slatted glass fronts and cabinets with roll-up fronts are especially space-saving as the doors do not extend into the room

AVENTOS flap systems

- Suitable for wall units with flaps, fold-and-lift doors and hinge-up flaps as well as tall units with lift doors and flaps
- Ease of movement is ensured for even large and heavy flaps
- With the infinite stop mechanism, the flap will remain in the desired position as long as the power storage is exactly set to match the front weight
- Fold-and-lift doors and hinge-up flaps are also available with optional ServoDrive



ServoDrive

- Electric motion assistance for hinge-up flaps and fold-and-lift doors
- Can be opened with a light tap and closed by pressing the easy-to-reach switch inside of the carcass
- Optional at an additional cost



Dresser unit with roll-up front

- Especially space-efficient opening as the doors do not extend into the room
- Carcass heights: 745, 1,258, 1,339, 1,402 mm
- Variable height available at an additional cost
- Roll-up-front colours: stainless-steel look, black, alpine white or slate grey
- Also available as clear glass, matte glass or black glass roll-up fronts
- Installation of interior shelf possible (ITAB-AJ)

HIGH-QUALITY SERVICE YOU CAN COUNT ON

Our promise: from development to production and delivery, we guarantee top quality along the entire product life cycle. To keep this promise, we have implemented clear processes internally to ensure our products meet the highest standards, and we support our retailers with comprehensive services, including designated representatives, individual consultation and practical training offers.



78

QUALITY PROCESSES

Our furniture is designed for everyday use and durability. Every material, every component and every product undergoes strict tests. From receipt to delivery, each step of the process is closely monitored. The awards we receive from independent testing institutes are a testament to our quality.

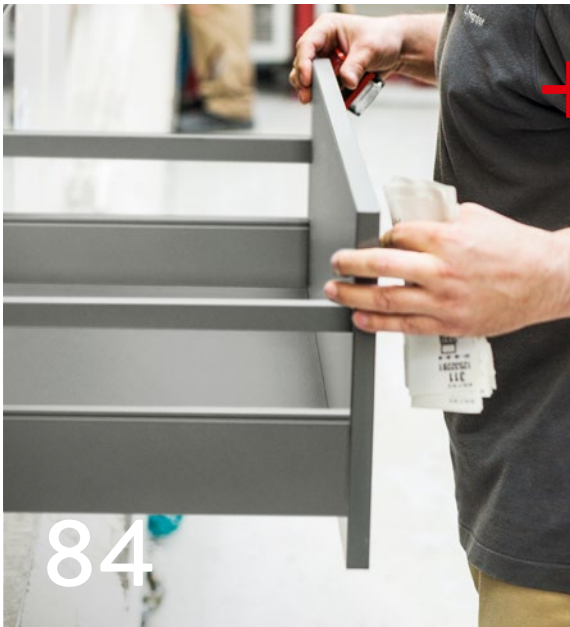

MADE IN GERMANY

We have chose Germany as our production location to ensure our products' high quality. To us, "made in Germany" represents high-quality materials, maximum automation and highly qualified employees.



PACKAGING AND ASSEMBLY

From edge protection to protective film: specially adapted transport packaging ensures that our furniture arrives to the customer safely and unscathed. Easy assembly is especially important to us and something we always keep in mind whenever we develop new products. This saves our retail partners' valuable time – and reduces costs and hassle.



SUSTAINABILITY

To us, sustainability means acting in a way that conserves resources and protects the environment in the long term. To ensure this, we consider every phase of our furniture's life cycle, prioritise energy-efficient business practices, conserve resources and invest in sustainable technologies.

SUPERIOR QUALITY THANKS TO INTENSE QUALITY MANAGEMENT

At nobilia, excellent quality management is at the centre of what we do – throughout the entire process chain, from the selection of upstream suppliers to the final on-site installation. This holistic approach has allowed nobilia to become an industry leader in terms of quality in recent years, a position it will continue to hold. Error prevention, precise analysis and targeted elimination: with our quality assurance measures and quality tests we are setting standards and guaranteeing products that exceed expectations and ensure maximum customer satisfaction. In this way, nobilia remains your reliable partner for top quality.



QM LAB

We ensure that our furniture is fit for everyday use. At the nobilia QM lab, our products undergo comprehensive and transparent testing throughout the entire value chain. Our customers see the work we put into new series: the “glass laboratory” in nobilia’s 230 m² showroom gives insight into the demanding tests that each product must pass before going into series production.



Qualified employees

From customer service, supplier management and incoming goods to production testing and the test lab, our quality management employees ensure that our strict quality management standards – which go far beyond national and international standards – are met in every area. By regularly conducting product audits, ramp audits (inspection of the unloading process), return analyses and training sessions for retail partners and assembly companies, we ensure that retail needs and consumer needs are always met.



Service life of at least 15 years

New developments undergo comprehensive testing in the lab before entering series production. Customer feedback, real-world experience and study findings are integral parts of the development process. All materials are tested to ensure they have a service life of at least 15 years.



Production-accompanying tests

To ensure consistently high series quality, furniture and individual components undergo production-accompanying tests at pre-established intervals. The QM test lab is uniquely well equipped for a furniture manufacturer and conducts all tests in-house according to DIN standards and DGM requirements.

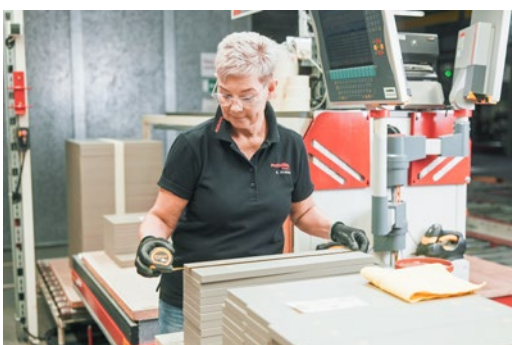

QM testing stations

Stringent tests are integral components of our production and ensure tested quality in every phase. This includes daily series process monitoring, for example manual front inspection, and additional testing that goes beyond DIN and DGM standards, such as the water bath test and worker self-review – creating perfect synergy between technology and the human eye. This is complemented by technology-aided in-line monitoring via AOI (automatic optical inspection).

COMPREHENSIVE TESTING PROCEDURES: QUALITY, FUNCTION AND DURABILITY

Our furniture – whether as individual components or assembled pieces – undergoes intensive testing before market launch. We simulate daily wear and tear in our plants and labs. The endurance testing systems test the furniture to ensure a service life of at least 15 years. In our QM lab we even subject our products to wear and tear for much longer than the DIN standard requires.



Behaviour under chemical stress

In this testing procedure we test the resistance of furniture surfaces to common household liquids and chemicals like red wine, acetone, coffee, olive oil and cleaning agents. These substances remain on the surface for a pre-determined amount of time according to the stress group in order to identify any possible discolouration or changes early on and to correct these issues if need be.



Heat test

The heat resistance of worktops is tested according to DIN 68930 – up to 180°C in dry heat and 100°C in moist heat. Everyday wear and tear caused by hot pots being placed on the worktop, for example, is also considered in order to test the material limits under extreme conditions. However, trivets should always be used to protect the worktops.



Water and steam resistance

Kitchen and bathroom furniture must be able to withstand extreme everyday conditions like moisture and heat. In the water bath, we test the durability of small areas and their imperviousness to water – the element that poses one of the biggest problems for kitchen and bathroom furniture. By applying steam, we also test the durability and imperviousness of carcass and front components.



Climate chamber

In the climate chamber we simulate artificial aging processes in order to test components under extreme climatic conditions. This provides information about our products' durability under various forms of climatic stress, such as container transport or use in tropical climates. This information can then be used to improve our products.



Salt spray test

Metal components such as handles are exposed to extreme stress in a fog of salt spray. In defined cycles over a period of 96 hours, for example, and at a testing temperature of approx. 35°C, we test whether the surfaces display any traces of corrosion.



Sunlight test

With a xenon arc lamp, we simulate the UV radiation that furniture is exposed to over the years. To do this, we artificially age the surfaces in order to determine the exact amount of discolouration and to identify any changes early on.

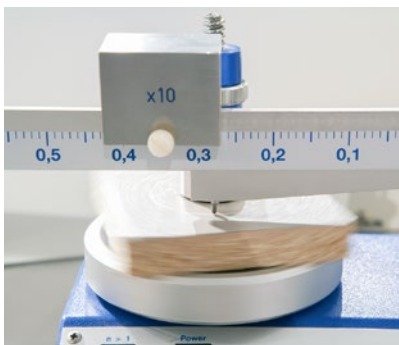

Abrasion resistance and scratch test

By simulating intensive use, the abrasion and wear resistance of our surfaces can be determined in order to ensure that they can withstand 15 years of life in a real-world kitchen. To do this, a diamond tip is applied to the surface with increasing pressure in order to create scratches, which are subsequently visually examined.



Endurance test

Our robot is programmed to simulate realistic, everyday kitchen conditions. While DIN standards specify minimum requirements, nobilia exceeds its own standards for more safety and durability. Drawers and pull-outs undergo 60,000 to 80,000 load changes, corresponding to opening and closing approximately 11 to 15 times per day. Hinged doors undergo 80,000.



Load capacity

In the lab, we continuously test the load capacity of top panels, bottom panels and shelves on the static wall. The mount and construction of wall units are designed to support up to 75 kg – considerably more than the weight of an 18-piece coffee set (approx. 5 kg).



AN EXTRA TOUCH OF QUALITY



- Our quality management ensures top quality, durable products and customer satisfaction

Durability tests

- Resistance to liquids and chemicals
- High heat resistance
- Imperviousness to moisture and water
- Simulation of aging under extreme climate conditions
- Corrosion resistance of metal parts
- UV radiation to test for discolouration

Endurance and load tests

- Simulation of real kitchen processes, such as opening/closing doors
- Test with at least 60,000 load changes in two weeks in order to meet the requirements of the RAL's "Golden M" quality mark
- Load capacity testing of top and bottom panels and shelves

OUR QUALITY SEAL

Quality, the environment and energy are essential elements of our company policy and are guided by the DIN EN ISO 9001, 14001 and 50001 standards.



Golden M

The German Furniture Quality Association (DGM) audited the company according to the RAL-GZ 430 quality standards and subsequently awarded nobilia with the RAL “Golden M” quality mark, thus ensuring that all kitchen, bathroom and living room furniture that leaves the factory meets current market expectations and quality requirements.



GS quality seal

The furniture auditing institutions of TÜV Rheinland have carried out a safety inspection of our products. Upon this inspection we were awarded the GS quality seal, certifying that we meet all requirements in terms of ease of use, durability, material consistency and safety.



Quality, environment and energy management certificates

Our integrated management system is regularly audited and approved by TÜV Süd. The requirements for quality management systems are established in ISO 9001 in order to ensure that customer needs and further product quality requirements are met. nobilia has been DIN EN ISO 9001-certified since 1994. ISO 14001 for environment management systems ensures the improved environmental performance of a company. nobilia has been certified according to DIN EN ISO 14001 since 2007. With certification according to the ISO 50001 energy management standard, which nobilia has had since 2013, companies are able to continually improve their energy efficiency. All three standards are recognised around the world.

OUR PROCESS OPTIMISATION AND DIGITALISATION

Error-free planning

Every customer order is reviewed electronically for planning errors and a visual record kept. With the order confirmation, the sales person receives a fast and clear review, including a detailed item list, floor plan, wall views and a perspective representation. Changes to the initial order confirmation are clearly marked. Our office sales staff save around 60 tonnes of paper each year by processing customer orders digitally via touchscreens.

Digital and efficient

Through direct electronic communication via EDI and extranet, our internal processing steps can be reduced to a minimum. This delivers nobilia kitchens to retailers, quickly and safely. From fully automatic order review (ATAK) to digital inspection protocols for kitchen assembly (MSA), we use modern tools for every step of the process, ensuring that everything runs smoothly. ATAK helps to quickly and efficiently identify errors, to correct designs and to secure margins – for example by adding missing required items. The software solution minimises planning errors, reduces complaints and ensures that your design is reviewed before a quote is prepared. This allows you to ensure quality and customer satisfaction in seconds.

ALWAYS THERE FOR YOU: OUR OFFICE AND FIELD REPRESENTATIVES



Designated office representatives

Three hundred staff members support around 10,000 customers around the world – always with designated representatives who know their retail partners and can provide individual consultation. The internal sales staff work hand-in-hand with the field staff to ensure smooth processes and provide expert support. With technical and business expertise, paired with the combination of “human eye” and digital tools, the internal sales staff guarantee that orders are precisely reviewed and reliably confirmed.



Field staff – your partners on the ground

We have the largest field staff in the kitchen sector. They support both national and international markets and offer their profound industry knowledge and technical expertise – real pros who understand our products inside out. And with the support of modern IT systems, up-to-date statistics and figures are always available to support the sales process. By working closely with you, our field staff have a precise understanding of your needs and those of your customers. That’s why they are actively involved in the development of new collections, fostering the continuous improvement of our catalogue. More than kitchen: our kitchen expertise is complemented by a team of specialists who possess broad expertise in bathrooms and living rooms as well.

GOODWILL FOR RETAIL PARTNERS

Reliable quality is the basis for strong customer relationships based on trust. At nobilia, our retail partners’ satisfaction is our top priority – and sometimes this means doing away with the red tape. Our furniture’s consistently high level of quality forms the basis of the partnership and goodwill that define our cooperation.

In order to provide our partners with the best possible support, nobilia has a 10-year goodwill policy for all furniture components manufactured by nobilia – this includes kitchen furniture as well as furniture for the living room and bathroom.

nobilia[®]
10
YEAR
GOODWILL

TRADITION AND INNOVATION – MADE IN GERMANY

nobilia has been paving the way in furniture production in Germany since 1945. These many years of tradition have allowed us not only to hone our craft, but also to realise that innovation and vision are essential for success. We manufacture exclusively in Germany at our four facilities. With our knowledge and expertise, we ensure top quality standards and maximum automation and process reliability. Thanks to our numerous initiatives and successful advancements, nobilia continues to set innovative benchmarks across the entire industry.

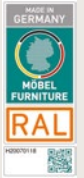

PRODUCTION LOCATIONS

Our four locations cover a total of 439,000 m², where our employees work in two shifts.



Plant I in Verl-Sürenheide and Plant III in Gütersloh

113,000 m² and 35,000 m²

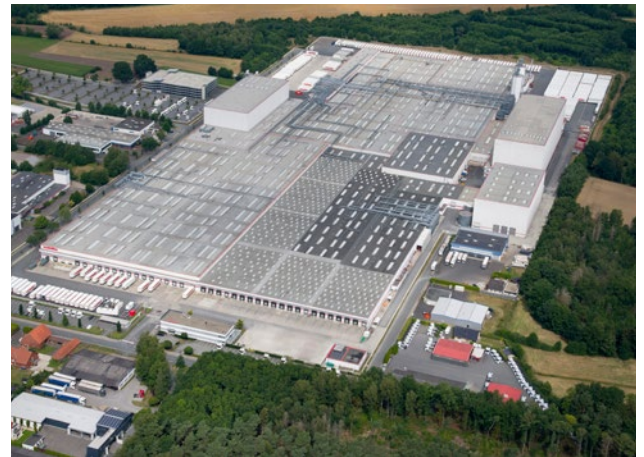

Plant II in Verl-Kaunitz

142,000 m²



Plant V in Saarlouis

149,000 m²

OUR STRENGTHS



Everyday professionalism

More than 3,900 commissions leave our facilities everyday, which corresponds to around 855,000 pieces of furniture produced each year.



Automated individuality

Each piece of nobilia furniture is completely one of kind – individually planned yet manufactured in highly automated series production. That's nobilia's unique expertise.



nobilia's vehicle fleet

With our own vehicle fleet we are able to ensure that our furniture is always transported correctly and professionally. Our highly qualified drivers guarantee a seamless and adept transport process.

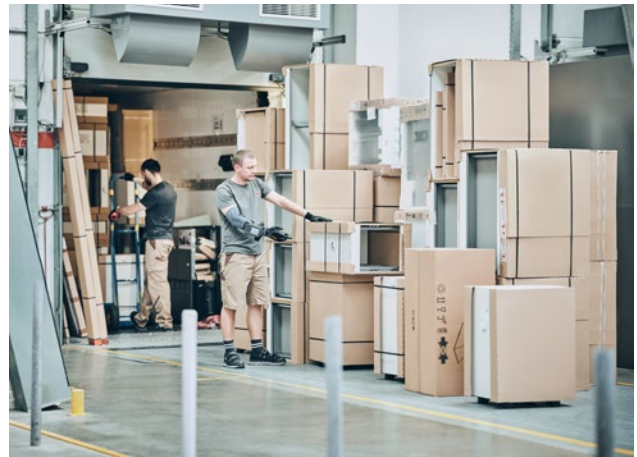

Delivery reliability at the highest level

Thanks to thorough scanning during loading and unloading, we have been able to achieve an extremely low unloading error rate of just 0.1%. With an on-time delivery rate of around 97.7%, the company's vehicle fleet has achieved top values in the furniture industry.



RELIABLE DELIVERY!

Managing our own vehicle fleet offers many advantages compared to only using external forwarders and guarantees high delivery quality, process reliability and on-time deliveries. This allows us to flexibly address and reliably meet customer needs and logistical requirements – like fixed delivery times, consideration of business hours and vehicle specifications. Every delivery is monitored: the driver scans the unloaded delivery items, while the on-board computer validates them and reports any errors. Missing components are automatically identified and defective items manually reported. A missing item report is sent directly to nobilia's manufacturing facility so that it can be remade and delivered as soon as possible.

PACKAGING CHARACTERISTICS



Optimal protection for every delivery

Sides and fronts are completely covered with cardboard and secured with nylon fasteners. Corner units receive self-adhesive corner caps to prevent damage during transportation. Worktops are wrapped in film and reinforced with cardboard edges or hardboard corners. Tall units are equipped with hard plastic corners at the bottom of the backside in order to prevent damages during installation.



Transport cross-beams

Appliance cabinets with raised appliance niches are secured with a transport cross-beam. This offers additional stability as long as the appliance is not yet installed.



Protective film

More delicate fronts, like our lacquered fronts, are secured with a special protective film during production and installation.

SUSTAINABLE PACKAGING SOLUTIONS

Transport packaging: optimal protection and recyclability

Our packaging concept makes an active contribution to sustainability by avoiding unnecessary materials while ensuring that the products are protected. We use biodegradable material made of 98% recyclable materials: Corrugated cardboard (91.1%), plastic strapping tape (1.8%), polyethylene film (7.1%) and very little styrofoam (0.06%). These materials are collected, sorted and recycled, with 98% of our packaging material remaining in the material cycle.

Reusable packaging: the circular economy for material protection

“The best packaging is the packaging that isn’t produced.” We take this sustainability credo seriously. We refrain from using packaging wherever technically feasible and turn instead to circular systems – particularly when it comes to regular material deliveries from our suppliers. We receive nearly all of the manufacturing components from these partners in reusable packaging. This packaging is sent back and reused when we are finished with it. In this way we are able to cut down on single-use packaging and close the loop in material flow.

Recycling made easy

To protect the environment, nobilia uses an efficient recycling system for transport packaging. In cooperation with our partner EKO-PUNKT, we collect and recycle packaging from the entire kitchen industry in a targeted way. Our retail partners only have to contact EKO-PUNKT – everything else is done for them. This does away with the hassle of disposal while benefitting the environment through sustainable recycling.



EFFICIENT AND PROFESSIONAL INSTALLATION

All cabinets are delivered pre-assembled. This saves assembly time and hassle.



Installation-friendly system

The nobilia kitchen system stands out through sheer ease of installation. Starting with the modular corner units for narrow stairwells to the fine adjustment of plinths and fronts and the fast-installation hinges for doors. Installation videos can also be found on our website.

Training programmes

With eight different seminar modules, nobilia offers comprehensive seminars and training sessions for the fields of sales and installation. Learn more about the training programmes at our installation academy.





nobilia LEADS THE WAY

Sustainability has long been a part of nobilia's DNA. We have put together a special team to address a range of challenges in eight core areas: raw materials, the supply chain, production, transport, retail, product use, durability and social issues. Our focus is on continuous improvement in every area – always with the goal of making measurable advancements. With an eye to the CSRD-EU ordinance, too, nobilia is taking appropriate measures to meet the highest standards of today and tomorrow.

OUR CORE AREAS



Regional raw materials

Where do the raw materials used in nobilia furniture come from? And: which raw materials are used? The materials used to make furniture has a major influence on its environmental footprint. At nobilia, we have long kept a close watch on the raw materials we use and take both their origin and recyclability into account.



Environmentally friendly supply chains

The topic of supply chains has entered the consciousness of consumers. The problem: in times of global trade, even a navigation error in the Suez Canal can have disastrous consequences on international supply chains. That's why nobilia works with regional suppliers whenever possible.



Sustainable production

Production makes up the largest part of our carbon footprint. The most waste is also produced in our facilities. For this reason, nobilia has initiated a number of measures aimed at reducing energy use and recycling production waste in a meaningful way or, if this is not possible, using it to generate heat. These measures are based on carefully reviewed figures and are being coordinated by a steering committee.



Environmentally friendly transport

The transport of goods makes up a large portion of our carbon footprint. Here, too, nobilia has implemented a series of measures. Some of them, such as the transition of the entire vehicle fleet to hydrogen, still need some time. Others, like the use of long trailers and optimised route planning, have already been implemented in daily operations. All follow a single goal: making the transport of our kitchens more sustainable.



Process optimisation in retail

Professional installation is an important aspect of sustainability. To prevent mistakes, nobilia founded the installation academy, offering qualified training to prospective kitchen installers. In this way we are able to help our retail partners conserve resources. During transport, too, we ensure safety and sustainability through the use of recyclable packaging. To ensure that this is recycled effectively, nobilia joined Recycling Kontor Transportverpackung (RKT).



Sustainable product use

The topic of sustainability is on consumers' minds – and is becoming an increasingly important sales argument. nobilia is the first choice for customers planning their kitchens for a number of reasons: we combine thorough inspections, emission-free components and high quality with numerous components and accessories that make life in the kitchen greener, more sustainable and more convenient.



Effective durability

At least 15 years – that's how long a nobilia kitchen can be used under normal wear and tear. But even the most durable product will reach the end of its service life at some point. For this reason, we apply insights from this phase to our product development process. Pollutant emissions and recyclability are important aspects here. nobilia uses safe, recyclable materials. Our products have received the DGM emissions label and many are even Blue Angel-certified.



Social responsibility

“Sustainability” has more than just one definition. At the United Nations Conference on Environment and Development in 1992, not only environmental and political goals but also social development goals were defined. As a family business, these are particularly important to us. Our social measures incorporate our employees, suppliers and neighbours from the region in equal measure.

Visit our website to learn more about our engagement for the environment and all of the details about our corporate responsibility.



OUR SUSTAINABILITY SEALS



www.blauer-engel.de/uz38

Blue Angel

nobilia has always been a pioneer in terms of quality and sustainability. The “Blue Angel”, the official environmental label of the federal government, can thus be found for many of our product lines. The seal denotes nobilia products that meet particularly high standards in terms of the environment, health and consumer protection.



PEFC certificate

The company is PEFC-certified, ensuring that the wood used for the production of furniture comes from sustainably managed forests and monitored sources. PEFC stands for Programme for the Endorsement of Forest Certification Schemes.



DGM emissions class

The furniture in this collection satisfies the requirements of emissions class A, the highest emissions class, in accordance with the award criteria for the emissions label of the German Furniture Quality Association.



DGM climate pact

nobilia became party to the German Furniture Quality Association's (DGM) “climate pact for the furniture industry”, once again highlighting the company's awareness of its responsibility towards the environment and the climate goals of the federal government and the United Nations. At the centre of the DGM climate pact is the determination of a company's CO₂ balance. This is continuously analysed together with a climate protection consultancy.

TSCA Title VI compliant / CARB2

For the production of its kitchen, bathroom and living room furniture, nobilia exclusively uses wood that meets the strict U.S. EPA Formaldehyde Emissions Standard of the Toxic Substances Control Act (TSCA Title VI), thus acting in compliance with American requirements for the reduction of formaldehyde emissions from wood that went into effect on 1 June 2018. The limits defined in TSCA Title VI correspond to those defined in the Californian CARB2 (California Air Resources Board) standard. The furniture is labelled “TSCA Title VI compliant”.

nobilia also fulfils the requirements of the Prohibited Chemicals Ordinance (Germany) as well as F-Four Star (Japan).





